

Morphological Fire Fighting Drone

Akshay B
Mechanical Engineering
Mount Zion College of Engineering
Kadammanitta, India

Jefin Varghese Philip
Mechanical Engineering
Mount Zion College of Engineering
Kadammanitta, India

Abstract:- Unmanned aerial vehicle or most commonly called as drones are UAV which are controlled by a radio signal. These drones use rotary motors for the propulsion of the machine. These are widely popular due to its easy building and low cost. Drones are now widely used in many sectors including security, transport, defense etc. There are huge opportunity in UAVs, our project focus on one very useful way of using drone technology for the betterment of the people. With specifically designed modifications a drone can be used as a firefighting drone. Many designs are already implemented in this area and research is done. Drone technology is improving very fast. Improvement in GPS navigation, automation of drone is huge leap in right direction. One such emerging technology in drones is Morphology Technology which help in changing the shape of drone. In our project we will combine these two ideas of morphological drone and fire fighter drone to create a working morphological fire fighter drone.

I. INTRODUCTION

Currently the firefighting is done by peoples and equipment's, which is done manually and put human lives at great risk. Our brave firefighters put there lives in danger to save the victims, but locating the victim can be only done by clear the path and manually look for the victim which is waste of precious time when it comes to life. So Fire Fighting Drone (FFD) is very good option in this case because it can be managed remotely without putting lives in danger. Now a lot of developments are going on fire fighter drones. In our project we will combine these two ideas of morphological drone and fire fighter drone to create a working morphological fire fighter drone. FFD will be operating high temperature environments, so designing should be done by keep that in mind. By the implementation of the morphing technology to the FFD efficiency of the system can be improved. By the addition of the system FFD will able to reach places where it cannot reach earlier and operation FFD will more easily in closed building.

1.1 PROBLEM STATEMENT

- Unable to detect the exact direction of fire source.
- To detect exact location of the fire source.
- Needs human effort and lacks safety.
- Equipment's or methods that are sensitive to heat and weather conditions

1.2 OBJECTIVES

- Designing and Analysis of a Morphological Fire Fighter Drone(MFFD)
- Improve Fire Fighting Drone technology to save life.
- Used for Extinguishing Fire in Inhospitable and Hostile Areas.
- To deliver the fire extinguisher ball in an area that is difficult to approach by conventional methods .(narrow passages, indoors)
- To inspect the environmental conditions and for live recording using first person view (FPV) camera.
- Also to navigate UAV through narrow passages and finding exact position for delivering the extinguisher balls
- This design project is to improve the ways in which fires are prevented and extinguished
- UAV's are the apparatus that is used for this mission and a human being does not need to be on board in order to control it.
- An innovative design is to be made for the dropping mechanism of the fire extinguisher ball which is mounted on the drone.
- The controller has the capability of inspecting the fire situation, coordinating the fire extinguishing operation, and assist the controller in maneuvering the vehicle

1.3 SCOPE OF STUDY

Firefighter drones are unmanned air vehicles which are remotely controlled by humans to extinguish fires. Companies are using electromechanical sensor technology for firefighting drones with the continuous development of advanced technologies. Firefighter drones help in wildfires, motor vehicle accident scenes, hazmat incidents, and even in rescue operations. Fire accidents lead to loss of lives, property damage, and fatal injuries to firefighters. Therefore, governments of various countries are encouraging the incorporation of firefighting drones and increasing the use of advanced technologies. Moreover, leading drones manufacturing companies are designing and developing advanced firefighting solutions with a higher degree of safety features and functionality. There is a growing demand in drone technology and Governments are funding for the future development of FFD. By the integration of the morphology technology to the FFD system it opens a huge opportunity of using the FFD Inside building like flat, factories plants etc. And by in cooperating High Definition Cameras to this system along with thermal sensors it can be used for survey and remote sensing of fire affected place, building, forest etc.

II. COMPONENTS

2.1 COMPONENTS & SPECIFICATION

- Frame
- Propellers
- Electronic Speed Control (ESC)
- Motors
- RC Transmitter
- CO2 Ball
- Electronic Flight Controllers
- Servo Motor
- Battery (LiPo)
- First Person View Camera
- Ardupilot

2.1.1 Frame

The frame is main body of the drone. Weight of the frame mainly depends on the material its made. Reference frame has a weight of 300g*. The distance from center mount plate to the motor mount is 60cm and the center of gravity is 30cm. All the electronically components like Flight Controller, Speed Control, Battery etc. are mounted on the center plate. For our design we are using Carbon Fiber as the frame material due to its strength to weight ratio and high heat resistance.

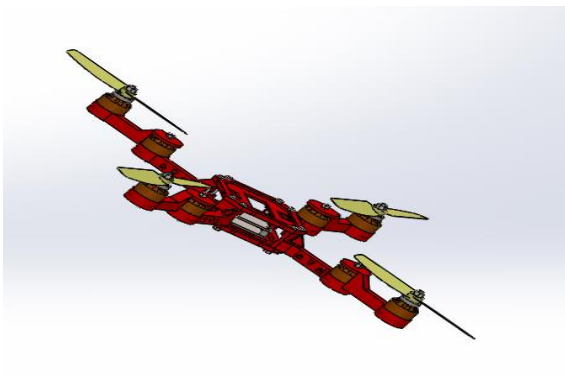

Figure 2.1 Frame

- **Composite Quadcopter Frame 1270mm**
- **Weight of Frame 300g**
- **Tarot IRONMAN 650 carbon fiber type**
- **Foldable Frame**
- **TL65B01**

2.2.2 Propellers

Propellers are used to create lift for the drone by mounting it in a motor. A drone has two type of propellers, Clockwise and Anti-clockwise. We are using a propeller of 15 in diameter and 5.5 in pitch.



Figure 2.2 Propellers

No: of blade -4

Carbon Fiber

Diameter -15inch

Pitch - 5.5 inch

Weight - 20.2 g / each blade (4)

Center Hole - 4mm section

2.1.3 Electronic Speed Control (ESC)

ESC controls the speed (RPM) of the motor according to the commands from the flight control. For this design we need ESC that can manage up to 60A. ESC is mounted on the center plate and input and out signals are soldered. Max RPM of the ESC is 24000 RPM.

- **YEP 60A (2-6S) SBEC Brushless**
- **Max current - 60A**
- **Input Voltage 2-6 cells**
- **Max RPM - 24000**

Weight - 63g (including Wires)



Figure 2.3 Electronic Speed Control (ESC)

2.1.4 Motors

Motor are used to spin the propellers to create lift and speed of the motor is controlled by the ESC. For drone motors used are normally brushless motors due to its high speed and no sparks due to no contact surfaces.

- **Motor Spec 5008 KV : 340**
- **Tarot 5008 KV : 340**
- **Cup head screws M3x8x4**
- **Button head screws M3x8x2**



Figure 2.4 Motors

2.1.5 Fire Extinguisher Ball

It contains the fire extinguisher substance which is used to put out fire. It weights about 1.3 kg.

Package Dimensions - 12 x 7.3 x 4.1 inch

Item Weight - 1301.81g

Fire Extinguishing Agent : (Non-Toxic) Mono Ammonium Phosphate



Figure 2.5 Fire Extinguisher Ball

2.1.6 Flight Controller

Flight Controller is the main controlling circuit of the drone. It controls and stabilizes the orientation of the drone in air without input from the user with the help several sensor built in to the circuit system. FC receives the signals from the user and sent video signals from camera, GPS etc. to the user. It is the brain of the drone.

Weight and Dimensions:

Weight: 38g

Dimensions : 81.5*50*15.5mm

Sensors:

3-axis - Gyroscope

3-axis- Accelerometer/Magnetometer

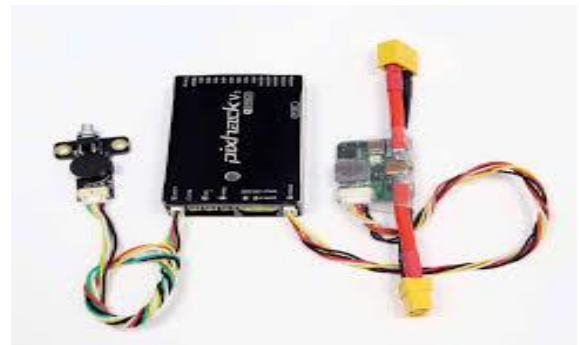

Figure 2.6 Electronic Flight Controllers

2.1.7 Servo Motor

Servo Motor is rotary actuator with a feedback mechanism. It is highly precise and it can rotate at specific angles. It has high torque, so it can be used as a rotating arm. It work using a servo mechanism.

- **Tarot 450 sport**
- **Operation voltage : 4.5-6v**
- **Size : 23.9*11.78*27.7mm**
- **Torque : 2.2 kg*cm at 6V**
1.8 Kg at 4.8V
- **Speed : 0.11sec/60° at 6V**
0.14sec/60° at 4.8V
- **Weight : 12g/motor**



Figure 2.7 Servo Motor

2.1.8 Battery (LiPo)

The battery is LiPo battery (Lithium Polymer). It is rechargeable battery available in many capacity. LiPo battery is used because it has high discharge compared to Li-ion battery. High discharge is need to feed the motor to create lift for sustained flight.



Figure 2.8 Battery (LiPo)

- **Minimum Capacity: 20000mAh**
- **Configuration: 22.2V/6Cell**
- **Constant Discharge: 10V**
- **Pack Weight: 2400g**
- **Pack Size: 200 x 90 x 60mm**
- **Charge Plug: JST-XH**
- **Discharge Plug: XT90**

2.1.9 First Person View Camera

First Person view camera consist of three components. FPV goggles, camera and transmitter. Camera capture the video and is transmitted by radio signal using a transmitter to the user wearing goggles to view the video. It can broadcast live feed from the camera to the goggles.



Figure 2.9 First Person View Camera

2.1.10 Ardupilot

Ardupilot is an open source UAV Autopilot Software Suite capable of controlling the UAV by itself. It contains different types of sensors which help in the automation process.

It is widely used in following :

- Multi rotor drones
- Fixed-wing and VTOL aircraft
- Helicopters
- Ground rovers
- Boats
- Submarines



Figure 2.10 Ardupilot

Ardupilot is open source so all the codes are available freely in GitHub.

III. PROJECT DESIGN

Steps Following

1. Define Projects Goals
2. Determine objectives and Outcomes
3. Study Regarding Project esigndentify Risks, Constraints and Assumptions
4. Designing Phase
5. Analysis of the Design
6. Documentation
7. Presentation

3.1 DESIGNING OF MORPHOLOGICAL FIRE FIGHTING DRONE

The main objective of the design is to extinguish fire using a fire extinguisher ball which is achieved by the use of a morphological fire fighting drone. Fire extinguisher is loaded to the drone with help of a dropping mechanism fabricated using aluminum. Aluminum is used because its light and easy to fabricate. It also serve purpose shielding the payload and electronic components from the fire, so it is fabricated as a metal box and dropping of the payload is controlled by the servo motor. Onboard camera is used to navigate the building. Along with that we are implementing the morphology technology to the drone. By the implementation of the morphology technology the over all cross section of the drone can be reduced thus allowing the small form factor drone to enter small spaces and put the fire out. Morphing of the drone is made possible by the use of four servo motor connected to the arm of the frame and the servo motor is controlled by the flight controller. This design can be seen in Figure 4.1 and 4.2

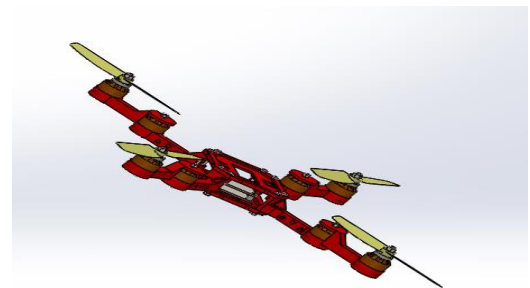

Figure 3.1(3D View)

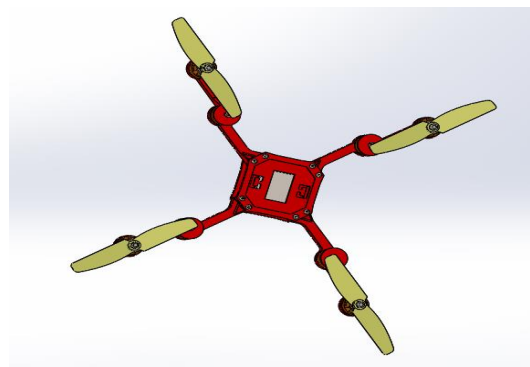

Figure 3.2(Top View)

Software used in the designing of the drones is Auto CAD and SOLID WORKS

There are many important components that are part of the morphological fire fighting drone. Therefore, Examine morphological fire fighting as a set of individual components according to the function of each system that conform a set.

These are the main system set of MFFD:

1. Fire Extinguishing Grenade
2. MFFD Control System : Entire function of the MFFD
3. Morphing Mechanism : Morphing of the Drone
4. Release Mechanism : Mechanism that control the release of the Fire Extinguish Grenade

3.1.1 Fire Ball Extinguish Grenade

This grenade is filled with an aerosol capable of extinguish fires using nitrogen mixed with potassium. The aerosol compound contains 70% of nitrogen and 30% of very fine particles of potassium. Using these two components, this method of extinguishing fires is successful in fully developed and in early stages fire. This grenade was designed to replace a Halogen fire extinguisher, since its method of operation is to cut off the oxygen supply of the area in which is used; therefore, it could cause serious harm to person if used inside a closed room. The physical characteristics of the fire extinguishing grenade can be appreciated in Figure. This grenade has a solid material system that is filled with a minimal amount of extinguishing compound. The compound acts directly on the flame; hence, having an uninterrupted interaction with the burning surface once the fire extinguishing chemicals are released. This device can be activated by thermal reaction, electronically or manually. The grenade is going to eject the potassium solid as aerosol in a 360 degrees direction and the total deployment time will be 40 seconds



Figure 3.3 Fireball

One of the advantages of this dispositive is that it keeps oxygen levels intact in case humans are in close range when the grenade is activated. Another important point is that it increases the safety of firefighting personal when they try to extinguish a fire. The fire ball can extinguish 3 types of fires. One of them is type 1A, which is fire that blazes fueled by solids such as wood, plastic, paper and cloth. The second type is 5B fire class, which contains substances such as inflammable material. The third type is C fire class,

which is used for electrical parts where water cannot be applied. The specifications of the fire extinguishing grenade are shown in Table4.1.

Feature	Value
Diameter (m)	0.145
Weight (Kg)	1.5
Volume of action (m ³)	9.12
Activate Time (sec)	3 to 10
Useful life (years)	5
Extinguish classes	1A - 5B - C
Fire Extinguishing Agent	Mono Ammonium Phosphate

Table 3.1 Fireball

3.1.2 MFFD Control System

3.1.2.1 Ardupilot APM 2.6

Ardupilot ARM 2.6 is used for the automation of the MFFD. It is a open source software suite and free to use.

- The GPS/Compass module may be mounted further from noise sources than the APM itself.
- APM 2.6 requires a GPS unit with an on board compass for full autonomy



Figure 3.4 Ardupilot APM 2.6

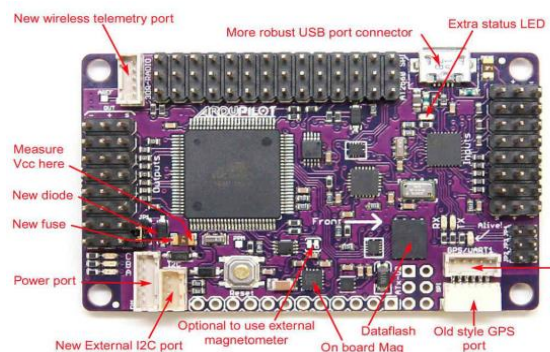

Figure 3.5 APM 2.6

3.1.2.2 Radio Transmitter

Radio Transmitter is the control system of the MFFD. User send signals to the MFFD by using Radio Transmitter. It used radio signal send commands to the MFFD. Radio signal send from the radio transmitter is received by the receiver in the FFD. The receiver binded to the Radio transmitter. The radio transmitter we are using is FLYSKY.

Figure of Radio Transmitter is given in the figure 4.7



Figure 3.6 Radio Transmitter

3.1.2.3 Transmitter Specifications

Channels	10
Model type	Quadcopter
RF range	2.4055 ~ 2.475 GHz
Bandwidth	500 KHz
Band	140
RF power	Less then 20 dBm
2.4G system	AFHDS 2A
Code type	GFSK
Sensitivity	4096
Low voltage alarm	Yes (lower than 4.2V)
PS2/USB Port	Yes
Power input	4.2V - 6.0V
Antenna length	26 mm*2
Weight	410g
Dimension (Length x Width x Height)	179mm x 81mm x 161mm
Color	White/Black
Certificate	CE0678, FCC

Table 3.2 Transmitter specifications

3.1.2.4 Receiver

Receiver is soldered to the system and it receive the signal from the transmitter.

Figure of receiver is shown in Figure 4.8

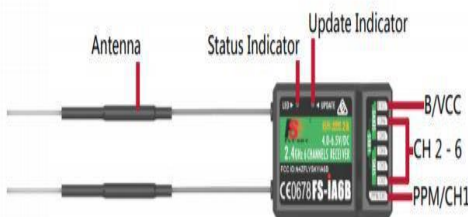

Figure 3.7

3.1.2.4.a Status Indicator

The status indicator is used to indicate the power and working status of the receiver.

- Off – The power is not connected.
- Lit in red – The receiver is on and working.
- Flashing quickly – The receiver is binding.
- Flashing slowly – The bound transmitter is off or signal is lost.

3.1.2.4.b Binding

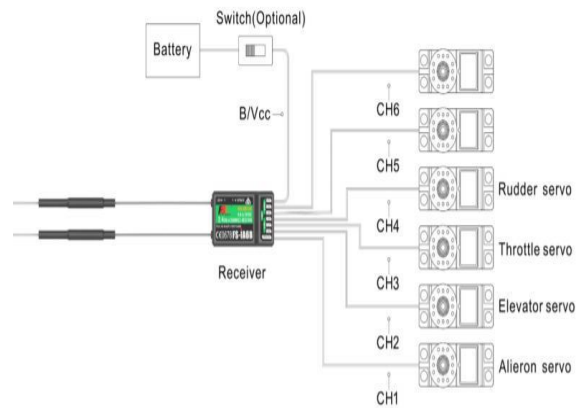

Figure 3.8 Receiver and Servos connection

3.1.2.4.c Sticks Mode

The system has 4 stick modes to change from.

Mode 1	Mode 2
Left stick	Left stick
• Left/Right: Rudder	• Left/Right: Rudder
• Up/Down: Elevator	• Up/Down: Throttle
Right stick	Right stick
• Left/Right: Aileron	• Left/Right: Aileron
• Up/Down: Throttle	• Up/Down: Elevator

Table 3.3 Mode 1 and Mode 2

Mode 3	Mode 4
Left stick	Left stick
• Left/Right: Aileron	• Left/Right: Aileron
• Up/Down: Elevator	• Up/Down: Throttle
Right stick	Right stick
• Left/Right: Rudder	• Left/Right: Rudder
• Up/Down: Throttle	• Up/Down: Elevator

Table 3.4 Mode 3 and Mode 4

3.1.2.5 Mission Planner

Mission Planner is a complete set of a ground station software for Ardupilot which is a open source autopilot software available for free to use in GitHub. Mission Planner can be used to configure path of the MFFD. It only runs on windows.

Any kind of UAV with different propulsion methods can be automated and controlled using mission planner

Image of the window while using mission planner is given below.



Figure 3.9 Mission Planner



Figure 3.13 Mission Planner Screenshot during flight

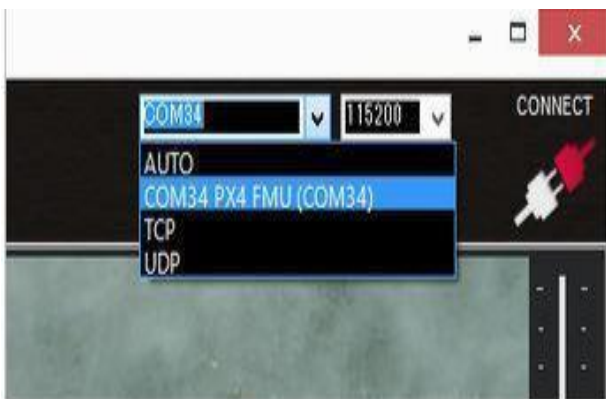

Figure 3.10 Com Port



Figure 3.11 Mission Planner Install Firmware Screen

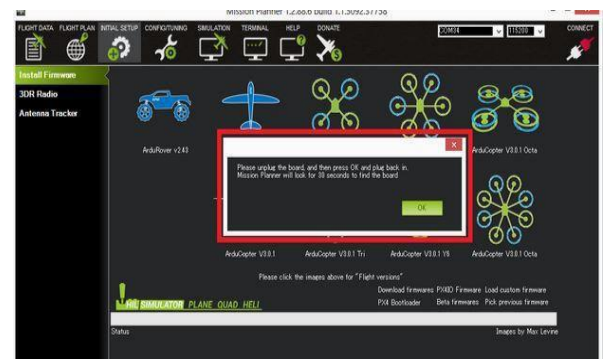

Figure 3.12 Mission Planner Firmware Prompt

Testing

The firmware can be tested which is basically works by switching to the Mission Planner Flight Data screen and pressing the Connect button. The HUD should update as you tilt the board

3.1.3 Morphing Mechanism

Morphing Mechanism is used to reduce the size of the drone, so that it is able go in small space like windows, doors etc.

3.1.3.1 WORKING

The Morphing is done by splinting the arm of the drone into two.

- Stationary Arm
- Rotating Arm

Both of these arm are linked by using a Servo Motor. Rotation of the rotating arm is performed by the Servo Motor.

Servo Motor is wired to the Digital Output Channel in the Flight Controller and that channel is binded to the transmitter.

Servo Motor is stepper motor with feedback system so the correction is done automatically.

Base of the Servo Motor is connected to the Stationary Arm and Rotor is connected to the Rotating arm

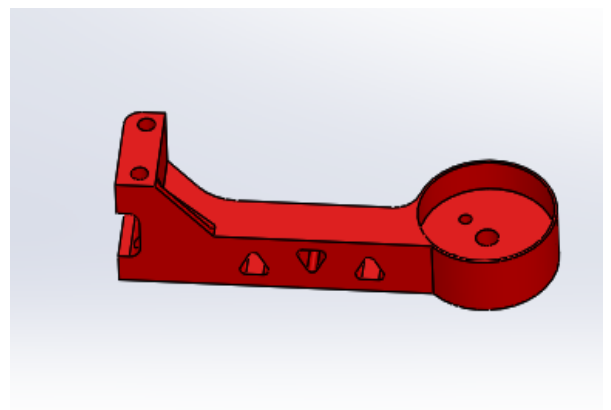

Figure 3.14 Stationary Arm

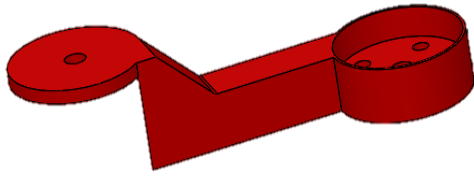

Figure 3.15 Rotating Arm

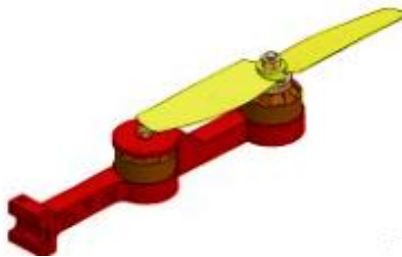

Figure 3.16 Fully Assembled Arm

3.1.3.2 Fabrication of Frame

3.1.3.2.a Material : Carbon Fiber

Carbon Fiber is the most popular material used in drones. It is light weight and high tensile strength. In our MFFD we are also using carbon fibre due to its high temperature resistance, high tensile strength and its light weight.

3.1.3.2.b Compression Molding

Compression Molding is a widely used for the fabrication of carbon fibre. Sheets of carbon fibre is placed in a heated mold and when the fibre is soften due to heat it is compressed at high pressure to form carbon fibre sheets.

These carbon fibre sheets are cut to needed shape by the use of CNC.



Figure 3.17 CNC machining Carbon Fiber

3.1.3.2.c Disadvantages of Carbon Fiber

Due extensive production procedures, solid carbon fiber sheets are quite expensive to produce. Carbon fiber also cannot withstand a high quantity of flexing cycles under high loading. It cannot with stand slow continuous loads. Bending of the sheet can weaken the bound. It has high tensile strength but low compressive strength. Carbon Fibre is expensive also.

3.1.4 Release Mechanism

The main objective of the design is to extinguish fire using a fire extinguisher ball which is achieved by the use of a morphological fire fighting drone. Fire extinguisher is loaded to the drone with help of a dropping mechanism fabricated using aluminum. Aluminum is used because its light and easy to fabricate. It also serve purpose shielding the payload and electronic components from the fire, so it is fabricated as a metal box and dropping of the payload is controlled by the servo motor. The material of the mechanism is aluminum, which has a light weight and is easy to manufacture. The disadvantage of this design is the close distance to the fire the quad copter has to get at the releasing point, since not only the ball has to be protected from the fire during the flight but also the motors and electronic components need to be isolated for high temperatures.

- The Release Mechanism is actually a remotely activated micro-servo motor
- It is actuated by using a micro-servo motor and remotely triggered using the remote controller.
- We are using a LED control module to power the Release Mechanism

3.1.4.1 Components in the Release Mechanism

- Micro-Servo – MG90D (High Torque Metal Gear)
- Extension Jumpers Wires
- Lithium Ion Polymer Battery
- LED Control Module
- Case

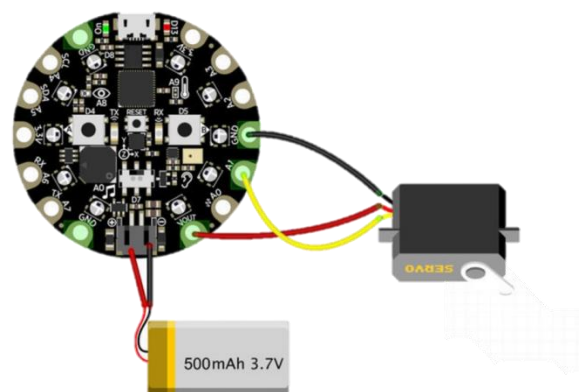

Figure 3.18 Circuit Diagram

Connections

- Servo :
- RED** : Wire is connected to **VOULT**
- YELLOW** : Wire connected to the **A1 (Signal)**
- BROWN** : Wire Connected to the **GROUND**

• Battery :

On board battery is connected to the JST Port on the LED Controller Module

3.1.4.2 Fabrication of Dropping Mechanism Case

3.1.4.2. a Material : Aluminum

Aluminum is a widely used metal in aircrafts. It is Light weight and high strength. Fabrication is easy and cheap. Aluminum holds it's strength even at high temperature.

Fabrication of box for dropping mechanism can be easily done by using Aluminum and it can protect internal payload and electrical components from heat also.

3.1.4.2.b Machining

Sheet of Aluminum can be easily cut to desired dimensions of the case of the dropping mechanism by the use of metal cut-off saw.

These plates can be welded to make the casing for the dropping mechanism.



Figure3.19Maching of Aluminum

3.2 CALCULATIONS

3.2.1 Force and Moment

$Wt. = mg = 50000N$ (Downward)

For Lift Force Required : $2 \times mg$

• 0
10,000N

For Sustained Hover : $F = (2 \times mg) + (20\% \text{ of } 2mg)$

F total = 12,000N

Force Acting on individual Motor : $F_i + F_t/4$ (* Quadcopter Has 4 motor)

$F_i = 30000N$

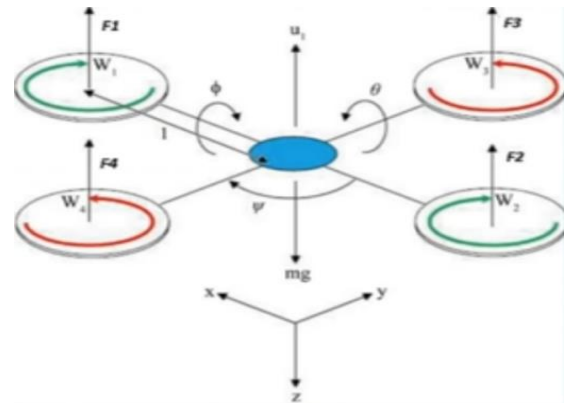

Figure 3.20 Forces acting on the Drone

3.2.2 RPM Required to Produce Fi

Thrust Produced By a Propeller

$F_t + 4.4)10^{-8} \times RPM \times [d^{3.5}/srt(p)] \times 4.23 \times 10^{-4} \times RPM \times p$

RPM

P : Pitch in Inch

D : Diameter of the drone in Inch

RPM = 72513 RPM

3.2.3 Angular Velocity

$\omega = 2\pi N/60$

Angular Velocity $\omega = 7593.54$

3.2.4 Force Constant “kf

$F_i = k_f \omega^2$

Kf value of the drone is : 5.2×10^{-5}

3.2.5 Moment Constant “km”(Case)

Moment Acting In fully Extended Position

$D_o = 1.27m$

$R_o = m$

$M_i = F_i \times R_o$

$M_i = 1906Nm$

We will get km Value as :

$K_m = 3.3 \times 10^{-5}$

3.2.6 Moment Constant “km”(Case 2)

Km Value of the Drone in retracted Position

Resultant perpendicular Dist. : $R_{i1} = 0.32 m$

$M_{i1} = F_i \times R_{i1}$

$M_{i1} = 960 nm$

So we will get km value as $k_{1m} = 1.66 \times 10^{-5}$

3.2.7 Result

• $K_f = 5.2 \times 10^{-5}$

• $K_m = 3.3 \times 10^{-5}$

• $K_{1m} = 1.66 \times 10^{-5}$

3.3 LIMITATION

- High cost of manufacturing
- Limited Pay load of Fire Extinguisher Grenade
- High Fabrication cost of Frame
- Life span of electronic components will be low due to Exposure to high Temperature
- Flight time is low due to use Lipo Battery

IV. RESULTS AND DISCUSSIONS

A Morphological Fire Fighting Drone with FPV was designed and analyzed. First Person View which provides a real time vision of a fire affected area can reduce risk of fire accident for person which is involved in the rescue operation. First Person View is provided with the help of FPV camera and Goggles. By the Implementation of the Morphology Technology to the Fire Fighting Drone, the drone can pass through small spaces to enter the burning space and put out the fire. After locating fire place to extinguish fire, fire ball is dropped above the fire which is implemented by a dropping mechanism. Fire ball is used instead of water because this will enable to extinguish fire immediately after dropping the ball on the fire.

V. CONCLUSIONS

The main focus of this project is to design and analysis an unmanned aerial vehicle modified with Morphology mechanism and a mechanism to release the fire extinguisher balls remotely as a solution for firefighting. The main factors taken into account to help firefighters in every manner and to save their lives so that they won't directly with this problem by using this UAV and the user who operate this UAV can view the environment in 360 degree which help to detect the exact position of the fireplace and drops the fire extinguisher ball to the target place accurately and the camera attached records video and photographs for further needs. With the addition of Morphing of the unmanned aerial vehicle the user can easy navigate in small spaces and enter the building or room through small opening with out any compromise in the performance of the Drone. It also satisfy the requirements of the release mechanism is the ease of access to load the fire extinguishing grenade and dropping the ball and the material of the quad copter frame is resistance to high temperatures, the design of the load and drop mechanism won't interfere with the aerodynamics or stability of the unmanned aerial vehicle. Morphing of the drone won't affect the aerodynamics of the drone in anyway and does not compromise on it's functions also. The UAV is also cost effective so that the price point is below and affordable to the many underfunded firefighting departments.

REFERENCES

- [1]. D. Falanga, K. Kleber, S. Mintchevy, D. Floreanoy and D.Scaramuzza :The Foldable Drone: A Morphing Quadrotor that can Squeeze and Fly (http://youtu.be/jmKXCdEbF_E)
- [2]. Piotr Kardasz, Jacek Doskocz, Mateusz Hejduk2, PawelWiejkutand Hubert Zarzycki:Drones and Possibilities of Their Using(<http://dx.doi.org/10.4172/2165-784X.1000233>)
- [3]. Bas Vergouw, Huub Nagel, Geert Bondt and Bart CustersDrone Technology: Types, Payloads,Applications, Frequency Spectrum Issuesand Future Developments
- [4]. EtharaBalaVyshnavi,] Amareswari Ambati, GorantlaChamundeswari, GarreVineetha Automatic CO2 Extinguisher Fire Fighting Drone
- [5]. Manuj C, Adarsh M Rao, Rahul S, Suhas C N, Vismay K G Design and Development of Semi-Autonomous Fire Fighting Drone
- [6]. Burchan Aydin, EmreSelvi , Jian Tao and Michael J. Starek Use of Fire-Extinguishing Balls for a Conceptual System of Drone-Assisted Wildfire Fighting
- [7]. Cesar Beltran, Miriam Carolina Freita and Alex MoribeUNMANNED AERIAL VEHICLE WITH FIRE EXTINGUISHING GRENADE RELEASE ANDINSPECTION SYSTEM