

Performance Enhancement of Low Pressure Turbine Cascade by Introducing Tubercles

Pradeep Kumar Behera¹, P Vasantha Kumar²

School of Aeronautical Sciences, Hindustan Institute of Technology and Science
1, Rajiv Gandhi Salai (OMR), Padur, (Via) Kelambakkam, Chennai - 603 103

Abstract:- This paper studies the performance characteristics of a Low Pressure Turbine Cascade with and without introducing tubercles. The focus of the project is on improvement in the performance of the turbine cascade. Improving the turbine performance in turn improves the efficiency of the engine. In the present work, tubercles are introduced onto the leading edge of a low pressure turbine cascade so as to enhance its performance in terms of its lift and surface pressure distribution. CFD analysis has been carried out on the blades of a low pressure turbine cascade with and without tubercles at zero incidence. Both the results are compared and conclusions are drawn as to which blade has better performance. Blade profile used in both the simulations is T106 turbine blade at a Reynolds number of 1.6×10^5 . From the simulations method not fully turbulence model with transition model has been used & observed that the pressure difference between the suction and pressure surfaces increases for the blade with tubercles. For the T106 blade without tubercles, separation starts at nearly 76% of chord whereas for the blade with tubercles separation starts at nearly 82% of chord. The present computational investigation shows that flow separation on the LPT cascade is delayed by the use of leading edge tubercles for an extent of 6% of the chord.

Keywords:- Low Pressure Turbine Cascade, Tubercles, Low Reynolds number, Transition model.

I. INTRODUCTION

The performance of aerodynamic the LPT (Low Pressure Turbine) is dependent on various parameters like Reynolds number, incidence and blade angle. LP turbines in aircraft engines undergo tremendous losses at cruise conditions. Engines like Gas turbine engines are mainly designed to perform better at high Reynolds Numbers, especially during takeoff and landing. But at the time of high altitude cruise, in thin air conditions and low velocities. In turbofan engines for example, it drives the low-pressure compressor and fan. Due to a characteristically large number of stages and components, the LPT comprises 20-30% of the total engine weight. An increase in LPT efficiency may reduce that component's weight and improve the fuel consumption of an aero-engine. This leads to decrease in efficiency of LPT, especially at low Reynolds number flows, where laminar separation is observed. As a result, various flow control devices, active and passive such as vortex generators, surface grooves, surface dimples etc. are tested with the intention of

modifying or controlling separated boundary layer transition on LPT blades, particularly at low Reynolds. The main problem with active devices is that they need additional power supply devices which add more weight to engine and they are less practical in a turbine environment.

II. COMPUTATIONAL METHODS

A. Software used in the project

ANSYS FLUENT is a strong and scalable general-purpose computational fluid dynamics software package used for industrial applications for model flow, turbulence, heat transfer and reactions the physical models allow precise CFD analysis for a wide range of fluids problems - from airflow over an aircraft wing to combustion in a furnace. ANSYS ICEM CFD is meshing software from ANSYS product. It has capability of meshing large and complex models. Both Hexahedral and tetrahedral mesh is carried out for any 3D complex geometry with advanced control. CATIA V5 (an acronym of Computer-Aided Three Dimensional Interactive Application) is multi-platform software suite for computer-aided design (CAD), computer-aided manufacturing (CAM), computer-aided engineering (CAE), PLM and 3D developed by French company Dassault Systems.

B. Geometry Generation

The geometry of the T 106 turbine blade is obtained from the coordinates that are obtained from Thesis of Steiger. MS Excel was used to import the coordinates into Ansys. The blade thus obtained has an axial chord of 52 mm and a chord of 60 mm. The stagger of the blade is 30.7 deg. whereas inlet and exit blade angles are 37.7 deg. And 63.2 deg. Respectively. The blades in cascade are spaced by 48 mm. Periodic boundary conditions are applied to the blade to get the desired cascade effect.

C. Domain generation

Domain for the blade geometry is obtained in Ansys using values and coordinates obtained from numerical calculations. As mentioned above periodic boundary conditions are applied so as to get cascading effect and that conditions are applied between upper and lower surfaces of the aerofoils which are placed at a distance of 24 mm above and below the actual aerofoils. The inlet of the domain is placed at a distance of 1.5 Chord length from leading edge whereas exit is placed at a distance of 2 chord length from the tailing edge of the aerofoil.

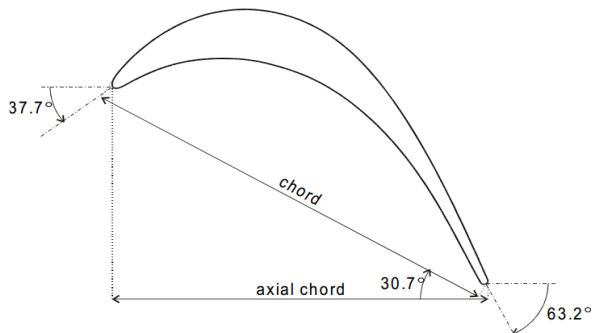

Fig 1:- Schematic diagram of T106 Blade

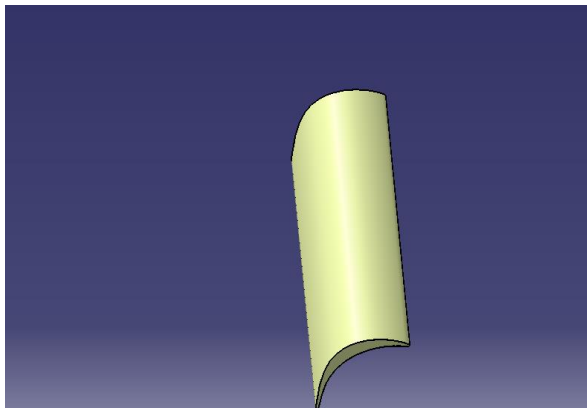

Fig 2:- 3D view of T106 Turbine Blade

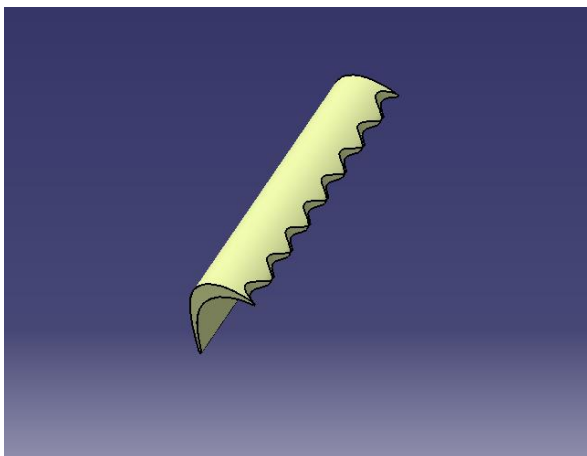

Fig 3:- 3D view of T106 turbine blade with tubercles

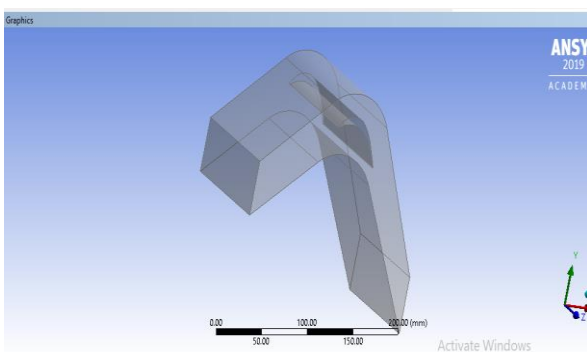

Fig 4:- Full domain with Reference Blade

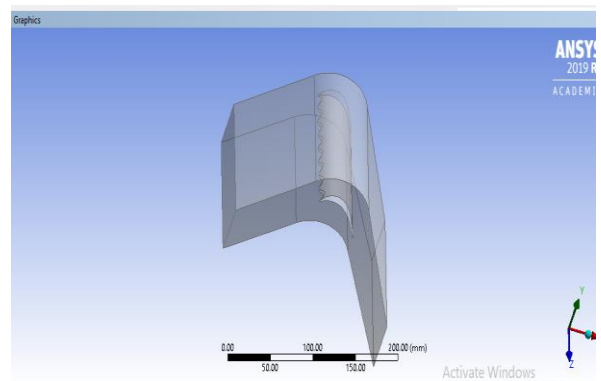

Fig 5:- Full domain with Tubercles Blade

D. Grid generation and grid independency

The grid is generated using ANSYS-AUTODYN. The clustering towards blade. A very fine mesh is created around boundary layer to get accurate results. Y+ online calculator is used to capture the boundary layer and some layers are given as per results obtained in Y+ calculator grid created is tetrahedral. The mesh thus obtained is unsymmetrical in nature with fine.

ANSYS
2019 R2
ACADEMIC

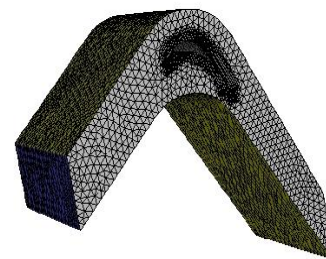

Fig 6:- Coarse Mesh

ANSYS
2019 R2
ACADEMIC

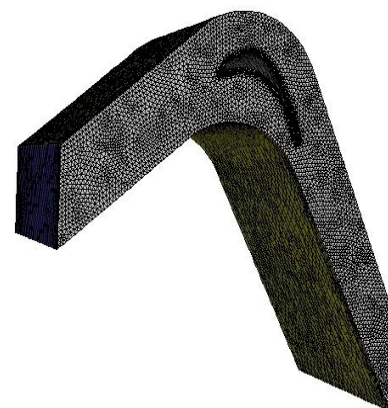

Fig 7:- Medium Mesh

ANSYS
2019 R2
ACADEMIC

ANSYS
2019 R2
ACADEMIC

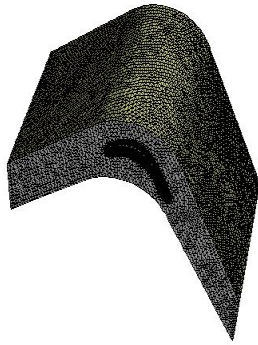

Fig 8:- Fine Mesh

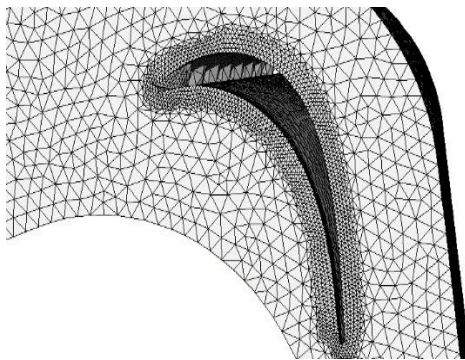

Fig 9:- Mesh Near to Blade Surface

| Grid | No. of elements |
|--------|-----------------|
| Coarse | 153623 |
| Medium | 388764 |
| Fine | 474795 |

Table 1:- Details of grid used for Meshing

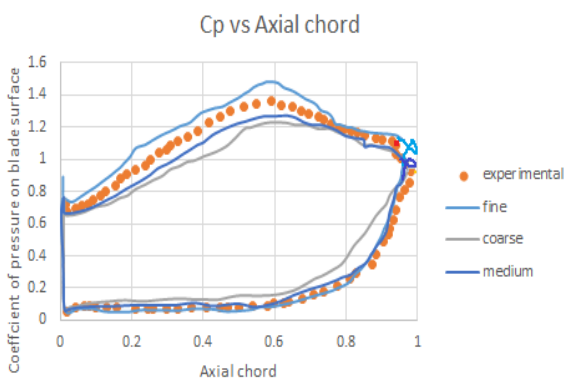

Fig 10:- Validation of mesh, Experimental (steiger's_thesis)

III. RESULTS & DISCUSSION

Computational investigations were carried out on both the blade designs i.e. with and without introducing of tubercles. The computations have been carried out for the Reynolds number of 1.6×10^5 at zero incidence. The performance parameters chosen for this analysis are coefficient of static pressure, velocity, turbulent kinetic energy and vorticity of the flow over the blade surfaces. The results thus obtained for both the blade configurations are compared with each other and conclusions are drawn.

A. Blade without tubercles

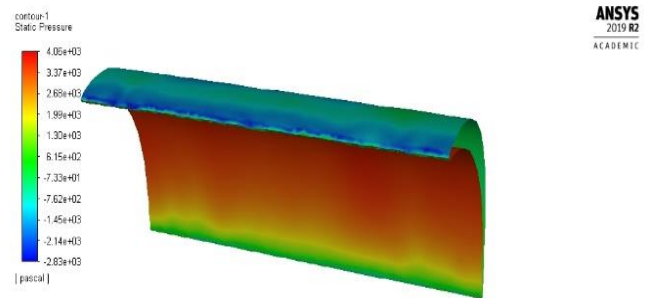

Fig 11:- Static pressure contour on the pressure surface

Above, the results of the flow computation of the LPT blade without tubercles is considered. Figure 11 shows the static pressure contours on the pressure surface of the blade. It is seen that there is considerable more of static pressure on the surface.

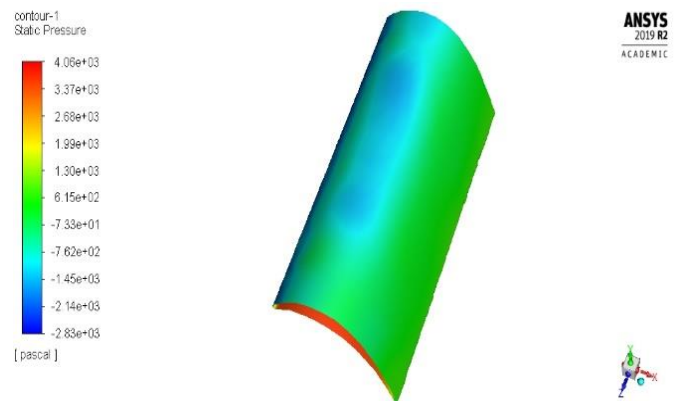

Fig 12:- Static pressure contour on the suction surface

Figure 12 gives the static pressure contours of LPT blade on the suction surface. It is seen that there is considerable lowering of static pressure on the surface.

E. Governing equations:

The Equations of the Reynolds-averaged Navier-Stokes (RANS) are time averaged equations of motion for fluid flow motion. Such equations can be used with approximations based on knowledge of the properties of flow turbulence to provide the Navier-stokes equations with estimated time averaged equations.

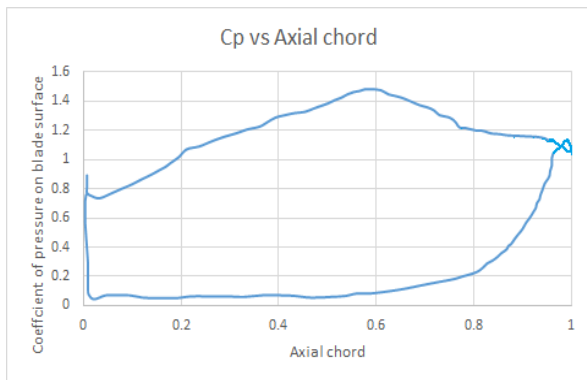

Fig 13:- Coefficient of pressure distribution on the blade surface vs axial chord

The coefficient of pressure distribution on the suction and pressure surfaces of the blade is plotted in Figure 13. With the suction peak is at 60% of the chord, the flow decelerates downstream and separation occurs at 76% of the axial chord location. The pressure plateau is clearly seen from 76% to 95% of the chord indicating that the separation extends upto 95% of the chord. At this location, pressure recovery begins with energising of the separated shear layer due to transition.

Vorticity is a measure local rotation of the fluid which is mathematically defined as the curl of the velocity field. Analysis of vorticity at the blade surface helps in checking whether or not the leading edge modifications contribute to the energising of the laminar boundary layer.



Fig 14:- vorticity contour of Basic blade at leading edge

Figure 14 shows the vorticity contours on the blade surface of the baseline blade profile. As expected, there are low levels of vorticity at the leading edge of the blade.

In order to understand the effect of the modifications at the leading edge, the level of turbulent kinetic energy at the leading edge gives an indication of the nature of the flow at the leading edge.

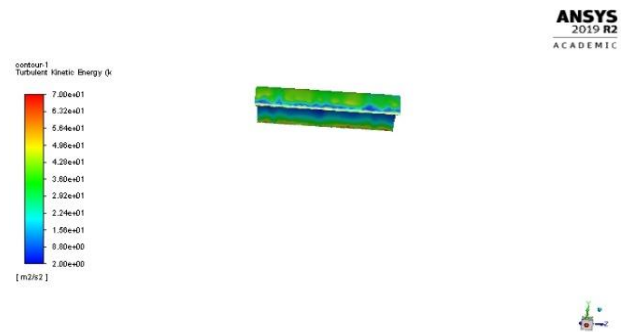

Fig 15:- Turbulent Kinetic Energy contour of Basic blade on leading edge

Figure 15 shows the turbulent kinetic energy levels at the leading edge of the baseline blade. Here again, as expected, the turbulent kinetic energy levels are low as the vorticity levels are low.

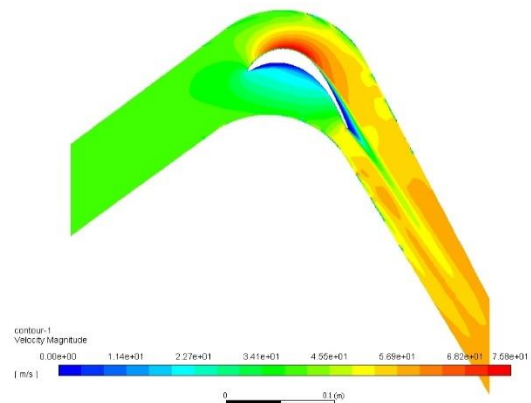

Fig 16:- Velocity contour of Reference blade

Figure 16 shows that velocity contour of the baseline blade of the cascade. The increased velocity on the suction surface is visible from around 25% of the chord and the suction peak is observed slightly aft of the mid chord. Thereafter, significant reduction in velocity is seen around three fourth of the blade chord indicating flow separation and this continues till the flow leaves the trailing edge. On the pressure surface, the velocity is low from near leading edge till about 60% of the chord. The velocity increases gradually downstream and with a higher value at the trailing edge.

B. Blade with Tubercles

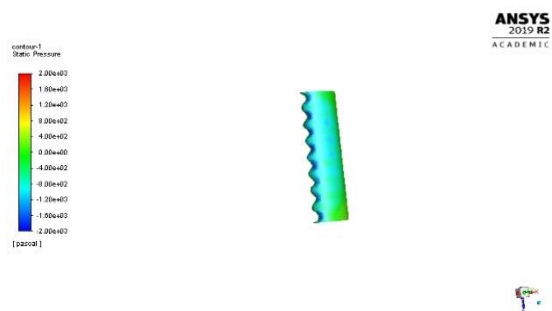

Fig 17:- Static pressure contour on suction surface

Fig 17 gives static pressure contour on the suction surface of blade with tubercles. The static pressure is low from leading edge till aft of the mid-chord. The pressure levels are lower than those of the baseline blade. The introduction of tubercles at the leading edge has resulted in lower static pressure on the suction surface than that of the baseline blade. Downstream of this there is gradual increase in pressure.

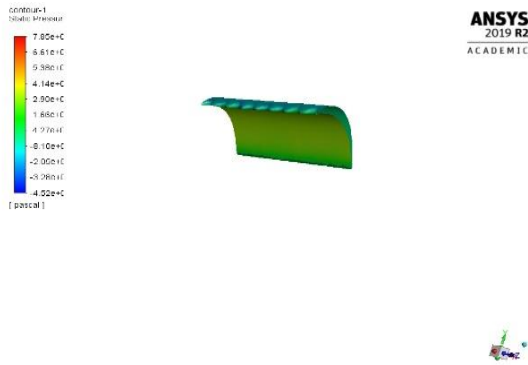

Fig 18:- static pressure contour of pressure surface

Static pressure contours on the pressure surface of the blade with tubercles is shown in Figure 18. A near constant pressure distribution until 90% of chord is observed after which the pressure decreases till the trailing edge. The overall pressure levels are higher than those in the case of blade without.

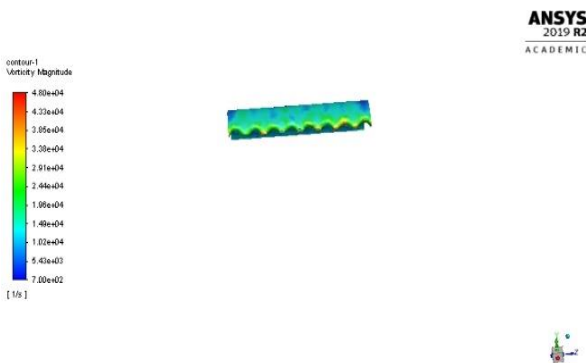

Fig 19:- Vorticity contour of blade with tubercles at leading edge

Fig 19 shows the vorticity contours for the blade with leading edge tubercles. In the sinusoidal shape of the tubercle at the leading edge it is seen that there is high vorticity at the trough locations of the tubercles. This can be attributed to the increased thickness due to the rearward reduction of the leading edge at the trough locations and also due to the flow experiencing a positive incidence at these locations.

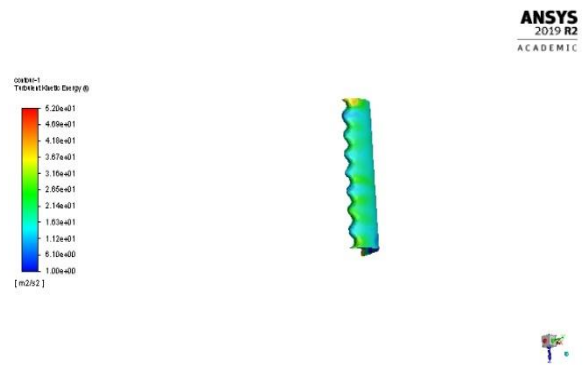

Fig 20:- Turbulent kinetic energy contour of blade with tubercles

Turbulent Kinetic Energy contour of the blade with leading edge tubercles is given in Figure 20. It can be observed that trough locations of the tubercles have increased levels of turbulent kinetic energy and this extends further downstream of the leading edge. This is a result of the increased levels of vorticity observed at the trough locations in Figure 19.

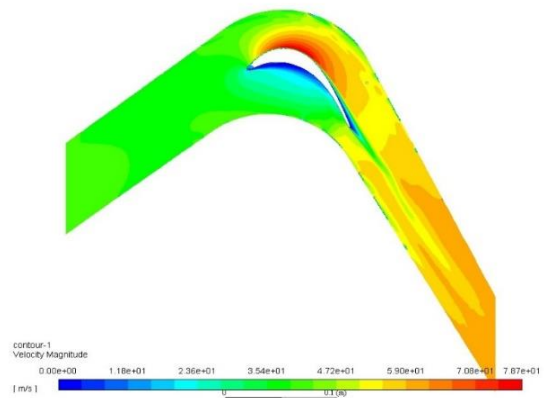

Fig 21:- Velocity contour of Leading edge tubercles blade

Velocity contours on blade with tubercles is shown in Figure 21. The velocity distribution shows that the region of high velocity on the suction surface extends further downstream from the suction peak with a corresponding lower levels of pressure on rear portion of the blade chord. Further reduction in velocity is significant only towards the trailing edge. However, on the pressure surface, there is considerable lowering of velocity with increased pressure starting from the leading edge and continuing upto the aft the blade chord. This effect is from the negative incidence due to the forward extension of the leading edge at the tubercle peak.

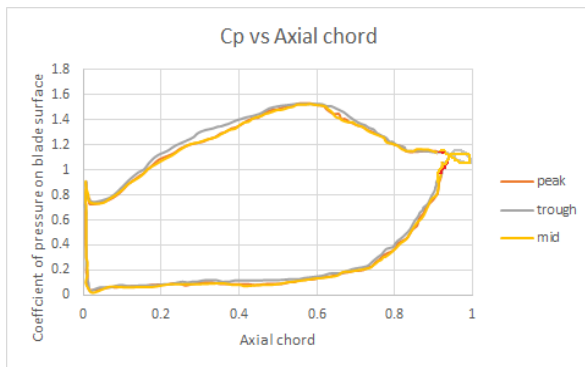

Fig 22:- Coefficient of pressure distribution for the blade with tubercles

Figure 22 gives the coefficient of pressure distributions for the blade with leading edge tubercles corresponding to the peak, mid and trough locations of the tubercle. The distributions for peak and mid locations do not show any significant variations. However, the coefficient of pressure corresponding to the trough location shows slightly higher values between 20 to 40% and from 62 to 70% of the chord on the suction surface. This follows the increased vorticity for the trough location.

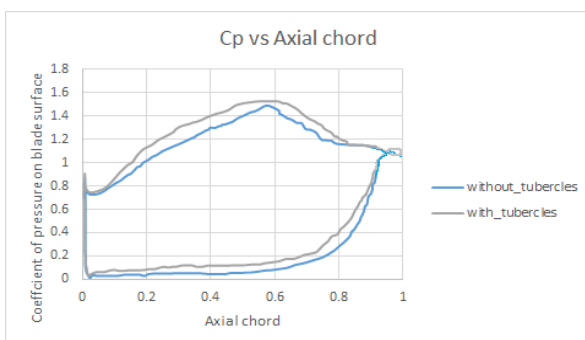

Fig 23:- Comparison of coefficient of pressure distribution

Comparison of the coefficient of pressure distribution on the blade surface between the baseline blade and the blade with leading edge tubercles is plotted against axial chord in Figure 23. While the location of the suction peak is the same for both the configurations, blade with tubercles show the increased levels of acceleration on the blade surface. For the blade without tubercles, separation starts at nearly 76% of chord whereas for the blade with tubercles separation starts at nearly 82% of chord indicating that the flow on the suction surface is more energized in the case of blade with tubercles compared to blade without tubercles.

IV. CONCLUSIONS

The computational investigations of the various parameters of T106 reference blade and blade with leading edge tubercles are carried out using Ansys CFX solver academic version 19.2. Pressure based solver is used for analysis with SST $k-\omega$ coupled with gamma-theta transition model. The simulation is carried out at a Reynolds number of 1.6×10^5 for zero incidence. At the inlet, velocity of 33 m/s is specified and zero gauge pressure is specified at exit.

Upon observing the results of the investigations of both the blades i.e. the basic blade and the one with tubercles, it is evident that for the blade with tubercles, performance parameters are better than that of the basic blade. The pressure over suction surface for the blade with tubercles is less than suction surface pressure of basic blade. The inverse can be said for pressure over pressure surface where the basic blade has less pressure when compared to blade with tubercles. That is, the difference in pressure between pressure and suction surface is greater for the blade with tubercles when compared to basic blade. This indicates that for the same incidence, introduction of tubercles increases the lift produced by the cascade blade.

The vorticity at the leading edge of the baseline blade is low compared with the blade with tubercles and there is high vorticity in the stream-wise direction at the trough region in the blade with leading edge tubercle. Similarly, the turbulent kinetic energy also shows an increase for the blade with leading edge tubercles compared to the basic blade.

The comparison of coefficient of pressure for blades with and without tubercles shows that the separation starts at nearly 76% of chord for the basic blade, whereas for the blade with tubercles, separation starts at nearly 82%. Further, the comparison of the total pressure loss coefficient indicates that the introduction of tubercles at the leading edge results in negative incidence leading to the thickening of the pressure surface boundary layer and the shifting of the wake towards the pressure surface.

It can be concluded that by using tubercles at the leading edge, the separation on the LP turbine blade surface is delayed by an extent of 6% of the blade chord. Therefore, the design implications of the application of leading edge tubercles on the LP turbine blade are important.

ACKNOWLEDGEMENT

I would like to extend my heart full and deepest thanks to Prof **Dr.P Vasanthakumar** for giving me his kind and able support. I have the great pleasure in expressing my sincere whole hearted thanks to him. At this occasion, I must emphasize that this project would have not been possible without the highly informative and valuable guidance by my faculty **Dr. N. Sitaram**.

REFERENCES

- [1]. Asghar, A., Allan, W.D.E., LaViolette, M., and Woodason, R., "Influence of a novel 3d leading edge geometry on the aerodynamic performance of low pressure turbine blade cascade vanes," Proceedings of ASME Turbo Expo 2014: Turbine Technical Conference and Exposition, June 2014.
- [2]. Gajanan, Viswanath, K., and Sitaram, N., "Computational and experimental investigations of separation control of low pressure turbine cascade blades using Gurney flaps," 6th Asian Symposium on

Computational Heat Transfer and Fluid Flow, December 2017.

- [3]. Hansen, K.L., Kelso, R.M., and Bassam, B.D., "Performance Variations of Leading-Edge Tubercles for Distinct Aerofoil Profiles," *AIAA Journal*, Volume 49, No. 1. 2011.
- [4]. Keerthi, M.C., Abhijit Kushari., Ashoke De., and Arun Kumar., "Experimental investigation of effects of leading-edge tubercles on compressor cascade performance," *ASME Turbo Expo Gas Turbine Technical Conference and Exposition*, 2014.
- [5]. Stieger, R.D., "The Effects of Wakes on Separating Boundary Layers in Low Pressure Turbines," *Ph. D. Thesis*, Cambridge University, UK. February-2002.
- [6]. Sudhakar S., N. Karthikeyan., and Suriyanarayanan P., 2019. "Experimental Studies on the Effect of Leading-Edge Tubercles on Laminar Separation Bubble", *AIAA Journal*, pp. 1-11.
- [7]. Volino, R. J., 2003. "Passive flow control on low-pressure turbine airfoils". *ASME paper GT2003-38728*.
- [8]. Sharma, O.P., 1998. "Impact of Reynolds number on low pressure turbine performance", *NASA CP 1998-206958*. pp. 65-70.