

Impacts of Body Area Network IEEE802.15.6 MAC Protocols on Medical Sensors Performances

EDDABBAH MOHAMED
MOUSSAOUI MOHAMED
LAAZIZ YASSINE
LABTIC. ENSA Tangier
Abdelmalek Essaadi University
Tetouan , Morocco

AITZAOUIAT CAHARF EDDINE
LATIF ADNANE
LABTIM ENSA Marrakech,
Cadi Ayyad University
Marrakech, Morocco

Abstract:- IEEE802.15.6 is one of the most appropriate candidate to perform remote patient health monitoring. WBAN. However for the special context of medical exploitation, IEEE 802.15.6 has many challenge to complet Thus, this protocol should have a high reliability and very low energy consumption. In this paper, we analyze IEEE802.15.6 MAC polling mechanism performances. The study is based on WBAN IEEE802.15.6 protocol specifications for standardized data rates under two Narrow Band frequencies. Finding results shows the originality of this study by recommending decisive factors to select the appropriate medical sensor Data Rate in order to decrease packets loss ratio and consequently improve reliability. Moreover, our presented recommendations decrease energy consumption and consequently increase sensors lifetime for medical sensors exploitation.

Keywords:- Polling; WBAN; IEEE802.15.6; Energy consumption, Medical Sensors.

I. INTRODUCTION

Wireless sensors networks (WSN) are the best candidate to perform medical patient remote monitoring [1][3], then performances evaluation are required to provide a high QoS medical systems. IEEE802.15 working group offers several standard for WSN, each standard has specific advantages in term of bandwidth, data rate, coverage, and energy consumption, the IEEE802.15.6 specifications provide one MAC layer and three possible PHY layer; Ultrawide-Band PHY layer, Narrowband PHY layer and Human Body Communication layer[1][2]. Current literature on WBAN gives particular attention to protocols performances simulation and evaluation [4]-[9]. However, some studies remain narrow in focus, while dealing only with simulator default protocols parameters. WBAN is intended to hold patients data, therefore a powerful performances study is important; authors in [4] use an analytical model to analyze contention-based CSMA/CA mechanism performance of IEEE 802.15.6 under saturation

condition and error prone channel. In a protocols performances study [5] authors studied the effect of contention-based access, pooling-based access, and schedule-based access on MAC performances. And in order to increase MAC energy efficiency authors in [6] propose a sleeping mechanism for CSMA/CA access. Authors in [7] they analyze different real sensors characteristics and priorities of IEEE 802.15.6 MAC that should be adjusted. In [8] authors study the IEEE 802.15.6 coexistence strategies and interference mitigation, a reference scenario; time shared, random channel CSMA/CA, is also done. Authors in [9] compare the IEEE 802.15.4 and IEEE 802.15.6 MAC performances, for medical applications for particular medical sensors data rate. Authors in [10] propose an adaptive priority-based MAC (AP-MAC) protocol with transmission opportunities for IEEE 802.15.6 WBSNs. To improve WBAN reliability and energy efficiency Authors in [11] present two novel and generic TDMA based techniques. In [12][13] for nodes carrying emergency data frames authors propose and analyze an efficient channel access scheme, to compute the average delay and reliability they also present an analytical model. In [14] to maximize WBAN sensors lifetime authors develop a methodology in two steps, maximizing batteries capacity, and saving this capacity by using low-power wireless sensor technologies and MAC mechanisms to minimize current consumption. All those studies provides an important insights into WSN MAC protocols performances evaluation and improving principally IEEE802.15.6 MAC protocol, but these studies and simulations would have been more useful if they had based on standards specifications and parameters and data rates. In this paper we study IEEE802.15.6 MAC protocols using OMNet++ Castalia simulator and taking into consideration possible Data Rates and frequency band for Narrowband physical layer. Our simulations are based on IEEE802.15.6 std specifications , the rest of this paper is organized as fellow, section 2 gives a brief overview of IEEE802.15.6 std, then section 3 begins by laying out the theoretical parameters of our simulations, and the results discussion in the section 4, in the end we conclude the paper.

II. AN OVERVIEW OF THE IEEE 802.15.6 STANDARD

The IEEE802.15.6 standard defines one MAC layer for different PHY layers, namely; NB (Narrowband), UWB (Ultra-wideband), and HBC (Human Body Communications) layers. The choice of a PHY depends on the use case, in this section we give a summary of the PHY and MAC layers specifications.

A. PHY Layers Specification
 ➤ *Narrowband PHY (NB)*

The Narrowband PHY is responsible for radio transceiver activation/deactivation and CCA (Clear Channel Assessment). The PPDU (Physical Protocol Data Unit) frame of is composed of PLCP (Physical Layer Convergence Procedure) preamble, a PLCP header, and a PHY Service Data Unit (PSDU) as given in Fig 1.

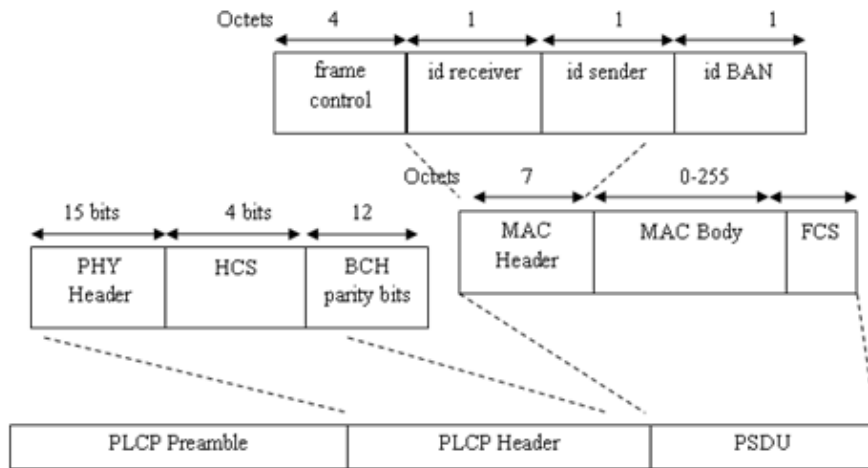

Fig 1:- NB PPDU structure

In the timing synchronization and carrier-offset recovery the receiver uses the PLCP preamble which is the first transmitted component. For a successful packet decoding, the PLCP header transmits necessary information. The PLCP header is transmitted in the operating frequency band using the given data rate in the header. The PPDU is the last component of the PSDU which consists of a MAC header, MAC frame body and FCS (Frame Check Sequence). The PPDU is transmitted after PLCP header using default data rates in the operating frequency band. A WBAN node must support transmission and reception in one of the frequency bands reviewed in Table1.

Band (Mhz)	Number of channels	Modulation	Symbol rate	Code rate	Spreading factor	Information data rate (kbps)	
402-405	10	PI/2-DBPSK	187.5	51/63	2	75.9	
		PI/4-DQPSK			1	151.8	
		PI/8-DBPSK				303.6	
420-450		GMSK M=2	187.5	19/31	2	57.5	
					51/63		75.9
					1/1	1	151.8
863-870 902-928 950-956	14 60 16	PI/2-DBPSK	250	51/63	1	101.2	
						202.4	
						404.8	
2360-2400 2400-2483.5	39 79	PI/2-DBPSK	600	51/63	1	121.4	
						242.9	
						485.7	
		PI/2-DQPSK				971.4	

Table 1:- NB Frequency Bands Specifications

The table shows the data-rate and the modulations parameters for PSDU and PLCP header. In narrowband physical layer, the standard uses DBPSK (Differential Binary Phase-shift Keying), DQPSK (Differential Quadrature Phase-shift Keying), and D8PSK (Differential 8-Phase-shift Keying) modulation techniques, except for 420-450 MHz frequency that uses a GMSK (Gaussian minimum shift keying) technique [19].

➤ *Ultra-Wideband physical layer (UWB)*

UWB physical layer uses a low band and a high band. The low band uses 3 channels (1-3). However the high band uses 8 channels (4-11). All channels are characterized by a bandwidth of 499.2 MHz. Fig. 2 shows the Ultra-Wideband PPDU, composed of a SHR (Synchronization Header), a PHR (PHY Header), and PSDU. The SHR contains a preamble and an SFD (Start Frame Delimiter). The PHR contains the data rate of the PSDU, length of the payload and scrambler seed. The PHR is used to decode the PSDU. The SHR is contains a repetitions of Kasami sequences of length 63. Usual data rates range from 0.5 Mbps up to 10 Mbps with 0.4882 Mbps as the mandatory one.

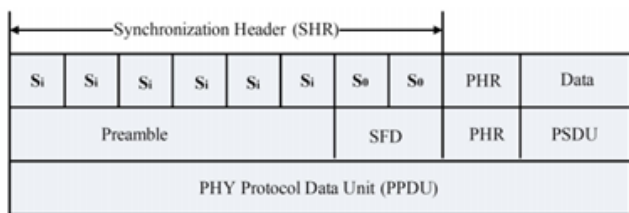

Fig 2:- IEEE802.15.6 UWB PPDU structure

➤ *Human Body Communications physical layer (HBC)*

HBC physical layer operates in 2 frequency bands centered at 16 MHz and 27 MHz with a bandwidth of 4 MHz [18]. HBC physical layer uses EFC (Electrostatic Field Communication), that covers the entire WBAN protocols,

such as packet structure, modulation, preamble/SFD, and the rest. Fig. 3 describes the PPDU structure of EFC. The PPDU is composed of a preamble, SFD, PHY header and PSDU. The preamble and SFD are fixed data patterns. The preamble and SFD are pre-generated and sent ahead of the packet header and payload. The preamble sequence is transmitted four times to ensure packet synchronization. The SFD is transmitted only once. The preamble sequence shows the start of the packet When the packet is received, and then SFD indicate the start of the frame.

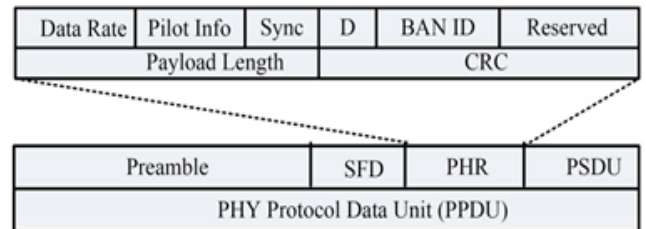

Fig 3:- IEEE802.15.6 EFC PPDU structure

B. MAC Layer Specifications

IEEE802.15.6 standard specifications divided channel into super frames. Super frame is comprised of beacons. All beacons have the same size. The hub selects the beacon period boundaries, transmits a beacon frame at every super frame beacon period. To inactive super frames the corresponding beacon transmission time is shifted, this process is done including a beacon Shifting Sequence field in the beacons of inactive super frame sequences. The hub transmits a beacon at every allocation time. The IEEE 802.15.6 MAC layer works under 3 modes, beacon mode with beacon period super frame boundaries, non-beacon mode with super frame boundaries, and non-beacon mode without super frame boundaries.

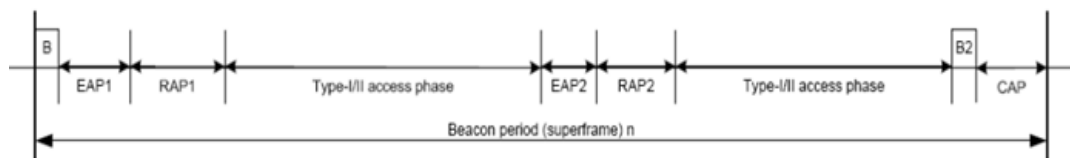

Fig 4:- Beacon mode with beacon period super frame boundaries

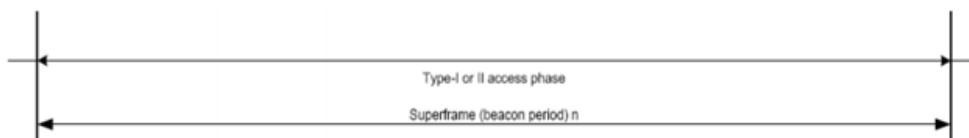

Fig 5:- Non-beacon mode with super frame boundaries

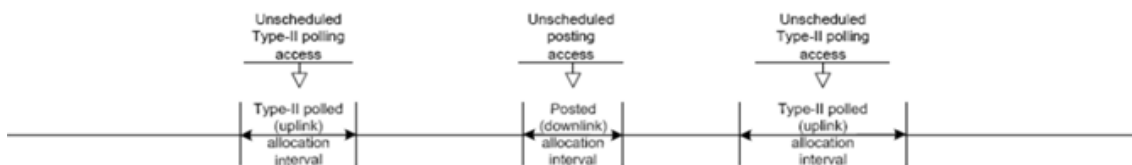

Fig 6: Non-beacon mode without super frame boundaries

- Beacon mode with beacon period SF (super frame) boundaries: The hub transmits a beacon frame in each beacon period during the issue of a SF but remains inactive otherwise. The SF structure of IEEE 802.15.6 consists of the following phases beacon, EAP1, EAP2 (Exclusive Access Phase), RAP1, RAP2 (Random Access Phase), Type I/II phase, Exclusive Access and a CAP (Contention Access Phase). (Figure 4)
- Non-beacon mode with SF boundaries: The hub can have SF only one in type I or II access phase. The transmission time is attached to the current SF start, given by timed frame T-Poll. The T-poll is an equivalent to the Poll frame that contain a transmit timestamp for SF boundary synchronization. The hoop can improvise in terms of post and poll allocation of the time frames. (Figure 5)
- Non-beacon mode without SF boundaries: The hub can provide only unscheduled type II polling access method. In this mode there are no SF boundaries. (Figure 6)

➤ Access mechanisms

The allocations in EAP, RAP and the CAP are more confined, CSMA/CA and slotted aloha access are the access methods that are used to get the allocations. If a hub or a node try to send data types frames in an emergency access phase with a high priority the hub attains allocation right at the start of the phase of EAP without affecting the CSMA/CA or slotted aloha access mechanisms. If the hub wants to transmit data either in the random access phase or the contention access phase, The allocation is constrained and does not have the pre-emptive privilege of an EAP.

- CSMA/CA: This access mechanism uses a back off counter and a CW (contention window) to get a new allocation. A node has the privilege to initiate, use, modify, abort or end a contended allocation. The node use its counter to a random integer value between one and a CW. CW varies depending on the user priority it

varies from CWmax to CWmin. Then the counter decremented constantly till a CSMA slot is equal to pCSMASlotLength. Data is transmitted When the counter reaches zero. The CW will be doubled and the channel will be busy if the counter reaches CWmax (higher priority).

- Slotted Aloha access: This access mechanism is based on contention probability. Based on this probability a node can obtains a new allocation in an Aloha slot. A node has privileges similar to CSMA/CA mechanism.
- Unscheduled access: To send polls or posts a hub uses unscheduled polling and posting access at any time across the frame. The active bit of the node will be set to 1 and the node will stay active making itself available for grant polled or post allocations which may be even unscheduled.
- Improvised access: Unscheduled polling and posting access can be used by the hub. In both polling and post allocations, it has the privileges of a RAP.

III. SIMULATIONS AND RESULTS ANALYSIS

A. simulation platform overview

Among the existing simulators, we chose the Castalia simulator to test the functioning and performance of our model in situations more in line with reality. Castalia [15] is a simulator for sensor networks which have very limited resources such as wireless body networks. It is based on the OMNeT ++ platform which is a simulation environment based on the C ++ language, is an open source application under the GNU license [15]. It is widely used to test algorithms and protocols in real wireless communication modules, with realistic behavior. Castalia offers the possibility of manipulating different layers of the OSI model. Indeed, it is possible to define MAC, Network and Application layers, thus making it possible to create networks of static or mobile nodes. Figure 7 shows how a simulation works on Castalia.

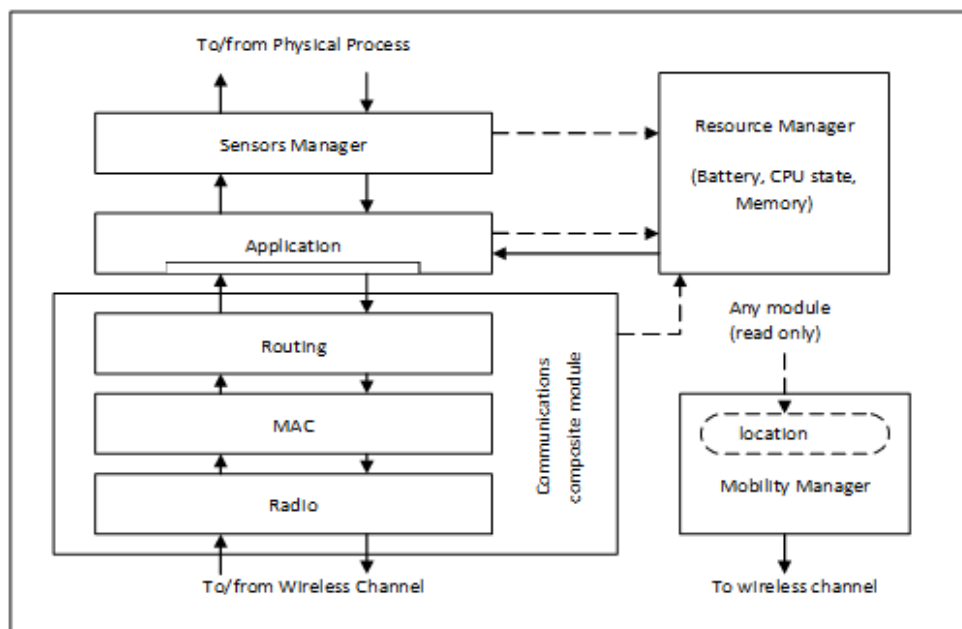

Fig 7:- Node composite module

B. Simulations Parameters

In this study, we consider a BAN network deployed on the human body where the position of the nodes is fixed, as presented in Figure 8, we consider 6 nodes placed on the right wrist, the left wrist, right ankle, left ankle, chest and left hip.

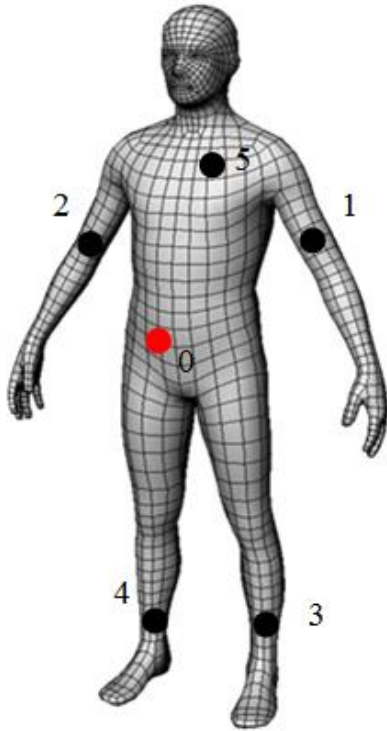

Fig 8:- Model of a BAN network deployed on the human body

The Path-Loss model used in the simulations is derived from experimental channel measurements performed by the NICTA group [16]. However, for each simulation scenario, the parameters of the path loss model must be properly adjusted to reflect the simulation scenarios as closely as possible.

The path fading PL (d) in dB as a function of the distance between two nodes can be modeled as a combination of the mean path loss PL₀ (d) and the shadowing and is written as follows:

$$PL(d) = PL_0(d_0) + 10\eta \log_{10} \left(\frac{d}{d_0} \right) + X_\sigma \quad (1)$$

Where $PL_0(d_0)$, is the path loss in free space (Equation1) at a reference distance d₀ generally equal to 1 meter, it depends on the frequency

$$PL_0 = 20 \log_{10} \left(\frac{4\pi}{\lambda} \right), \quad \lambda = \frac{c}{f} \quad (2)$$

η is the exponent of the path weakening, it depends on the environment.

Here, X_σ is a random variable that describes fading (shadowing) with a lognormal distribution with mean $\mu = 0$ and standard deviation σ .

The distribution function of the variable X_σ , is defined by [81]:

$$f(X) = \frac{1}{\sqrt{2\pi}\sigma} \exp \left(-\frac{X^2}{2\sigma^2} \right) \quad (3)$$

In the case where the path loss model of equation 1 does not give good results, we use an option given by the Castalia simulator, which explicitly defines a path loss map of all the nodes in A file. This means that the file contains the values of the path loss between each pair of nodes. In our simulation model, we defined 5 nodes and a coordinator (node 0), Table 3 shows the path loss values in dB between each pair of nodes from the experimental tests.

Node Node	0	1	2	3	5	5
0	0	56	40	59	54	58
1	56	0	52	52	58	61
2	40	52	0	58	54	61
3	59	52	58	0	50	63
4	54	58	54	50	0	63
5	58	61	61	63	63	0

Table 2:- Values of the Lowering of the DB Route Between the Nodes

Another very important aspect of the radio channel is the temporal variation. In our simulation, we are based on the model implemented in the Castalia simulator drawn from experimental measurements [17]. The model is based on the Gamma distribution of probability density function:

$$f(x|a, b) = \frac{1}{b^a \Gamma(a)} x^{a-1} \exp \left\{ -\frac{x}{b} \right\} \quad (4)$$

$\Gamma(\cdot)$ is the gamma function

In the Castalia simulator, we have introduced the radio parameters of the Narrow-band physical layer of the IEEE 802.15.6 standard for two frequency bands 902Mhz-928Mhz and 2.4Ghz-2.4835Ghz, These parameters are: the frequency band, the bit rate, the modulation type, the number of bits per symbol, the bandwidth, the sensitivity and the power consumed. Tables 3 and 4 give the different radio parameters defined in the band 2.4-2.4835 GHz and in the band 902-928MHz respectively.

Bit rate	242,9 Kb/s	485,7 Kb/s	971,4 Kb/s
Modulation	D-BPSK	D-BPSK	D-QPSK
Number of bits per symbol	1	1	2
Bandwidth (MHz)	1	1	1
Sensitivity (dbm)	-90	-87	-83
Power consumption (mw)	3,1	3,1	3,1
TxOutputPower (dbm)	15	15	15

Table 3:- Radio Parameters Defined In the Band 2.4-2.4835 GHz

Bit rate	202,4 Kb/s	404,8 Kb/s	607,1 Kb/s
Modulation	D-BPSK	D-QPSK	D-8PSK
Number of bits per symbol	1	2	3
Bandwidth (MHz)	0,4	0,4	0,4
Sensitivity (dbm)	-91	-87	-82
Power consumption (mw)	3,1	3,1	3,1
TxOutputPower (dbm)	15	15	15

Table 4:- Radio Parameters Defined In the Band 902-928 MHz

The other parameters used in the simulation model are listed in Table 5

Slot allocation length (ms)	10
Mac Buffer	48
Number of Slots allocation	32 (RAP length= 32- EAP length)
Noise Floor (dBm)	-104

Table 5:- Simulation Parameters

In this simulation model, routing is not used, because on the one hand, we use a star network managed by a coordinator. And on the other hand, we want to evaluate the performance of the MAC layer without influence of the upper layers.

C. IEEE 802.15.6 MAC performances Simulations

The base MAC layer, of an IEEE802.15.6 BAN network, divides time into BI (beacon intervals). Each tag interval consists of several access phases: EAP1, RAP1, type I / II access phase, EAP2, RAP2, the type I / II access phase and the CAP. The hub or node can obtain time slots in EAP1 and EAP2, valid per access instance, only if it wants to send data type frames with the highest user priority. The access method can be either CSMA / CA or Slotted Aloha. In the MAP access phase, access to the channel is managed by the hub, which plans the allocation of slots. The polling access method is used in the MAP I / II access phase. The polling mechanism in the MAC base layer of the 802.15.6 standard is illustrated in Figure 9.

In this work, we are study the polling mechanism used by the MAC layer of the IEEE802.15.6 standard, we analyze, in particular, the impact of transmission rate and frequency band on performance of the BAN 802.15.6 network in the physical layer NB (Narrow Band) in terms of lost packets and energy consumption.

It is also assumed, in all simulation scenarios, that the packet rate of each node varies between 0.1k packets / s and 250k packets /s.

The narrowband physical layer (“Narrowband”, NB) is intended for the communication of sensors worn or implanted on the human body. It works mainly on three aspects, namely, activation and deactivation of the radio transceiver, Clear Channel Assessment (CCA) and data transmission / reception

Two hundred and thirty channels have been defined in seven operating frequency bands:

- 402 ~ 405 MHz (10 channels);
- 420 ~ 450 MHz (12 channels);
- 863 ~ 870 MHz (14 channels);
- 902 ~ 928 MHz (60 channels);
- 950 ~ 958 MHz (16 channels);
- 2360 ~ 2400 MHz (39 channels);
- 2400 ~ 2483.5 MHz (79 channels).

Our study covers two frequency bands: 902 ~ 928 MHz (60 channels), and 2400 ~ 2483.5 MHz (79 channels).

➤ Bande de fréquence 2.4-2.4835 GHz

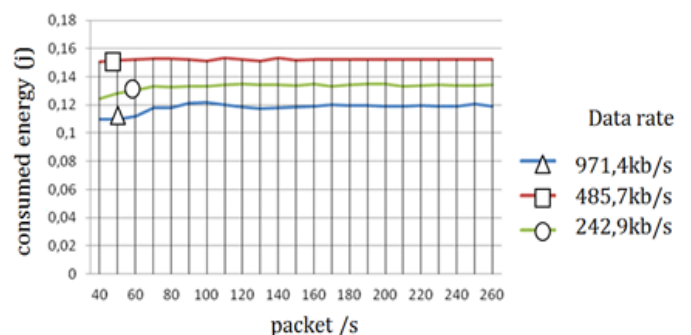

Fig 9:- energy consumption for the nb frequency 2.4-2.4835 ghz.

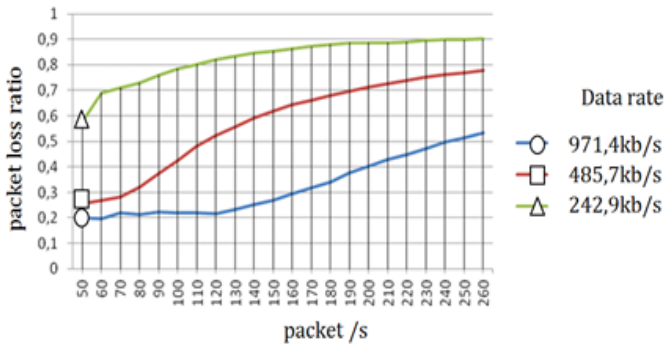

Fig 10:- packet loss rate for the nb frequency 2.4-2.4835 ghz.

➤ *Bande de fréquence 902-928 MHz*

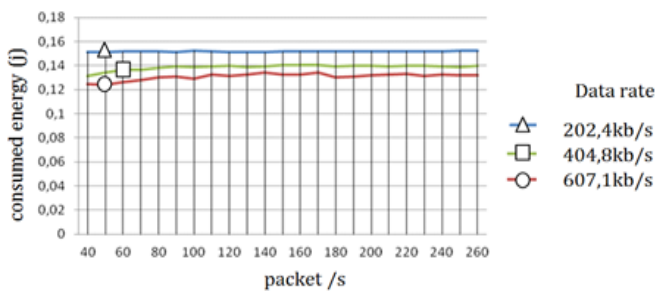

Fig 11:- energy consumption for the nb frequency 902-928 mhz

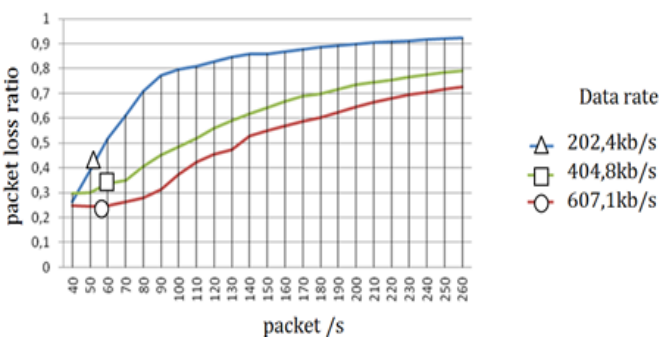

Fig 12:- packet loss rate for the nb frequency 902-928 mhz

D. Results Analysis

The MAC layer is responsible for the process by which each node has access to shared resources during a given period. The shared resource in this case is the wireless channel. There are different approaches, some are better suited than others, depending on the application. In general, they all try to achieve a low power consumption and a low packet loss ratio.

A BAN body network must interconnect sensors around or inside the human body, these sensors measure parameters predefined by a medical team, which implies different sending frequencies and subsequently different data rates. The NarrowBand layer standardizes several data rates and several frequency bands which makes it the most suitable for implementing a network of body sensors. However, the choice of data rates and frequency band impacts the of packets loss ratio and the energy consumption.

➤ *Packets loss ratio:*

Knowing that a BAN must communicate critical information from a patient, therefore a high packets loss ratio will delay communication and have a negative impact on quality of service [21]. The fewer the number of retransmissions, the better the reliability of data transmission. Retransmission occurs when a sending device does not receive an acknowledgment from the recipient (Figure 13). There are different reasons for not receiving the acknowledgment, i.e. loss of data packets due to collision on the receiving side, lost acknowledgment, late receipt of acknowledgment, etc. The high number of retransmissions guarantees reliability, but at the same time causes delays in network performance because retransmissions involve access of the same packet to the channel and bandwidth, which will affect the performance of other nodes, and cause additional energy consumption.

In our simulation the nodes send packets for 50 seconds. Thus, if the reception is perfect, we will reach 2000 packets per node for the case of 40 packets / s / node.

So;

$$N_p (\text{ideal}) = (\text{packet rate}) * (\text{simulation time}) \quad (5)$$

$N_p (\text{ideal})$: Number of packets received in ideal communication cases.

During a simulation scenario the receiver receives a number of N_p packets (received).

$$N_p (\text{received}) < N_p (\text{ideal}) \quad (6)$$

In this case the packet loss ratio can be calculated by the following formula:

$$TPP = (N_p (\text{received})) / (N_p (\text{ideal})) \quad (7)$$

The following diagrams explain the packet interactions between a transmitter and a receiver.

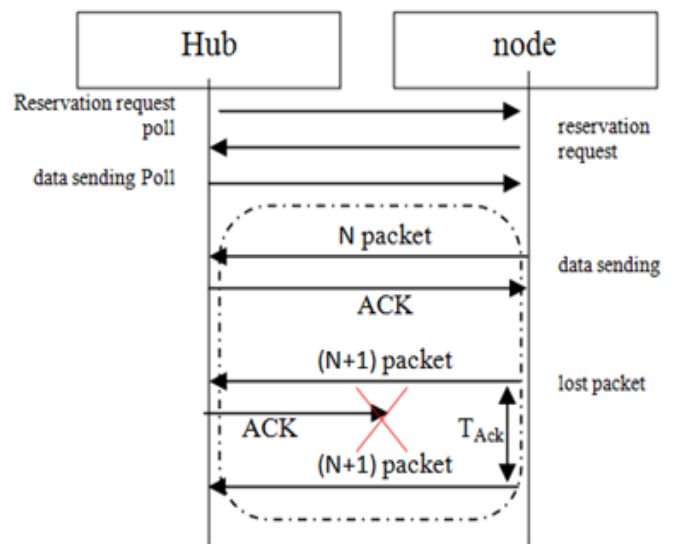

Fig 13:- Paquet perdu avec absence d'ACK .

$$T_ACK = C / (\text{data rate}) \quad (8)$$

IV. CONCLUSION

➤ Energy consumption

The energy consumed must be determined in each decision taken when designing a medical remote monitoring system [20], for example, if the nodes must wait for an acknowledgment from the base station before they can go to standby, this means more power consumption, more return of lost packets, less battery life time.

Energy consumption is also important, since a sensor / actuator implanted inside the human body must save its energy consumption in order to avoid surgical procedures for batteries replacement.

The IEEE802.15.6 standard operates in the narrowband frequencies 2.4-2.4835GHz, in our analysis we note that the energy consumption and almost invariable compared to the bit rate of packets sent per second for the three data rates 971.4kb /s 485,7 kb/s and 242.9 kb/s (figure 9).

Simulation results presented in figure 9, illustrates the energy consumption which is low for the data rate of 971.4 Kb/s while it increases for the weak data rates 242.9 Kb/s and 485,7 Kb/s.

The simulation result presented in Figure 10 shows that the packets loss ratio increases with the rate of packets sent per second, unlike the energy consumption which is invariable with this parameter. The result of this figure also explains that the packets loss ratio is very low for the data rate 971.4Kb/s compared to that of 242.9Kb/s

From the figures we notice that the packet loss ratio for the two NB frequency bands increases for low data rates and for high data rates the loss ratio is lower, this result is due to the optimization behavior offered by the polling mechanism because it allows dynamic and variable allocation of communication frames as already explained.

For high data rate the allocation offered by each node is efficiently exploited and thereafter the packet loss ratio becomes very low for high data rates, on the other hand for low data rates wasting the allocation given to the node is a direct cause of loss ratio.

The causality between the high loss ratio for low bit rates and the retransmission of lost packets creates another constraint on energy consumption.

As can be seen from the results figures, the low-speed scenarios generate significant energy consumption which has reached up to 0.15 joule and for high-speed consumption does not exceed 0.12 d where a significant gain in energy and flow especially for a medical application where the battery constraint is very considerable.

WBAN performances evaluation is essential, if not primordial when the network transmit patients data, the communication delay, the packet loss and the power consumption should be estimated to design a remote patient health monitoring platform with high QoS. Thus in our study we was interested more in the Narrowband physical layer possible data rates, for two important WSN QoS parameters; energy consumption and packet loss ratio. Running several simulations under tow frequency band 902MHz-928MHz and 2.4GHz-2.4835GHz, our study highlight an important issue about real data rate used by Narrowband physical layer. further works are needed for other physical layers

REFERENCES

- [1]. IEEE Std 802.15.6-2012 - IEEE Standard for Local and metropolitan area networks - Part 15.6: Wireless Body Area Networks
- [2]. Kwak, Kyung Sup, Sana Ullah, and NiamatUllah. "An overview of IEEE 802.15. 6 standard." Applied Sciences in Biomedical and Communication Technologies (ISABEL), 2010 3rd International Symposium on. IEEE, 2010
- [3]. Eddabbah, M., Moussaoui, M., & Laaziz, Y. (2019). A smart architecture design for health remote monitoring systems and heterogeneous wireless sensor network technologies: a machine learning breathlessness prediction prototype. International Journal of Intelligent Enterprise, 6(2-4), 293-310.
- [4]. Rashwand, Saeed, Jelena Misic, and HamzehKhazaei. "IEEE 802.15. 6 under saturation: Some problems to be expected." Journal of Communications and Networks 13.2 (2011): 142-148
- [5]. Al-Mazroa, Areej, and Nasser-EddineRikli. "Performance evaluation of IEEE 802.15. 6 MAC in WBANs-A case study." Information Technology and Multimedia (ICIMU), 2014 International Conference on. IEEE, 2014
- [6]. Jacob, Anil K., Geethu M. Kishore, and Lillykutty Jacob. "Lifetime and latency analysis of IEEE 802.15. 6 WBAN withinterruptedsleepmechanism." Sādhanā 42.6 (2017): 865-878
- [7]. Fourati, Hend, et al. "Performance evaluation of ieee 802.15. 6 csma/ca-based canetwban." Computer Systems and Applications (AICCSA), 2015 IEEE/ACS 12th International Conference of. IEEE, 2015
- [8]. Alam, Muhammad Mahtab, and Elyes Ben Hamida. "Performance evaluation of IEEE 802.15. 6-based WBANs under co-channel interference." International Journal of Sensor Networks 24.4 (2017): 209-221
- [9]. Ait Zaouiat, C. E., and A. Latif. "Performances Comparison of IEEE 802.15. 6 and IEEE 802.15. 4." INTERNATIONAL JOURNAL OF ADVANCED COMPUTER SCIENCE AND APPLICATIONS 8.11 (2017): 461-467

- [10]. Kim, Eui-Jik, et al. "Adaptive Priority-based Medium Access Control Protocol for IEEE 802.15. 6 Wireless Body Sensor Networks." *Sensors and Materials* 30.8 (2018): 1707-1713
- [11]. Salayma, Marwa, et al. "Reliability and Energy Efficiency Enhancement for Emergency-Aware Wireless Body Area Networks (WBAN)." *IEEE Transactions on Green Communications and Networking* (2018)
- [12]. Deepak, Kayiparambil S., and Anchare V. Babu. "Improving Reliability of Emergency Data Frame Transmission in IEEE 802.15. 6 Wireless Body Area Networks." *IEEE Systems Journal*(2017).
- [13]. Deepak, K. S., and Anchare V. Babu. "Enhancing reliability of IEEE 802.15. 6 wireless body area networks in scheduled access mode and error prone channels." *Wireless Personal Communications* 89.1 (2016): 93-118
- [14]. Zaouiat, C. A., Eddabbah, M., & Latif, A. (2016). Medical Sensors Lifetime Improvement: Scheduled IEEE 802.15. 6 MAC Layer Mechanism. *International Journal of Computer Science and Information Security*, 14(8), 7.
- [15]. The Castalia simulator for Wireless Sensor Networks: <http://castalia.npc.nicta.com.au>
- [16]. Gopalakrishnan Nair, Nithyia, P. J. Morrow, and Gerard Parr. "Design considerations for a self-managed wireless sensor cloud for emergency response scenario." (2011).
- [17]. D. Smith, D. Miniutti, L. Hanlen, D. Rodda, B. Gilbert, Dynamic Narrowband Body Area Communications: Link-Margin Based Performance Analysis and Second-Order Temporal Statistics, in *IEEE Wireless Communications and Networking Conference*, 2010.
- [18]. Eddabbah, M., Zaouiat, C. E. A., Moussaoui, M., & Laaziz, Y. (2016). Body Area Networks IEEE802. 15.6 HBC Physical Layer Performances: Bit Error Rate and Message Integrity. *International Journal of Computer Networks and Communications Security*, 4(7), 207.
- [19]. Eddabbah, M., El Ouatiki, B., Moussaoui, M., Laaziz, Y., & Zaouiat, C. A. (2016). Impact of BCH (51, 63, 2) code on IEEE 802.15. 6 performances. *International Journal of Computer Science and Information Security*, 14(8), 975.
- [20]. Eddabbah, M., Moussaoui, M., & Laaziz, Y. (2014, December). A flexible 3G WebService based gateway for wireless sensor networks in support of remote patient monitoring systems. In *Proceedings of 2014 Mediterranean Microwave Symposium (MMS2014)* (pp. 1-5). IEEE.
- [21]. Mohamed EDDABBAH, Mohamed MOUSSAOUI and Yassin LAAZIZ, "Performance Evaluation of a Smart Remote Patient Monitoring System based Heterogeneous WSN" *International Journal of Advanced Computer Science and Applications(ijacsa)*, 9(8), 2018. <http://dx.doi.org/10.14569/IJACSA.2018.090837>