

# A advanced charging system using RFID and for Power generation Foot step

Bhavna Rawal  
Student  
ABES Engineering College  
Ghaziabad, Uttar Pradesh, India

Isha Dayal Sharma  
Student  
ABES Engineering College  
Ghaziabad, Uttar Pradesh, India

Shalini Rajput  
Student  
Electronics & Communication Engineering  
ABES Engineering College  
Ghaziabad, Uttar Pradesh, India

Shivangi Gupta  
Student  
Electronics & Communication Engineering  
ABES Engineering College  
Ghaziabad, Uttar Pradesh, India

Rakhi Kumari  
Faculty, ABES Engineering College  
Ghaziabad, Uttar Pradesh India

**Abstract:-** It is well-known fact that with a daily hike in population graph of the country the power consumption is also increased simultaneously in parallel to the increased consumption its wastage also has risen to the higher side so the transformation of waste energy brings back to usable form is not only major task as well as it is needed of hour. With increased population density and development of Technology has more diverging to the use of the more and more electronic gadget, devices, on the other hand, conventional power generation method is going short day by day and urgent need a ride to search for an alternate method of power generation E.g.: solar energy (renewable energy) at the same time it's time to consider about power wasted through human action to overcome this crisis the waste energy is converted to useable form with the help of piezoelectric sensor As the pressure exerted on the sensor is converted into voltage by using energy conservation method footstep power generation is used for charging a gadgets like mobile phone through USB cable.

**Keywords:-** Piezoelectric, Renewable Resources, LCD, Battery, Microcontroller, USB, RFID.

## I. INTRODUCTION

Energy is anything which gives us the ability to do work. We also know that how rapidly the population is increasing day by day hence it is becoming very difficult to fulfill the requirements of every individual. Also, we know that today we cannot imagine our lives without electronic items. But the major challenge we face in using them is the charging and for charging we use electricity thus to fulfill our requirements of electricity we are exploiting the resources at a speed. Thus, to overcome this problem we have a solution named Footstep power generation which is based on the principal of piezoelectric effect. It is the effect in which certain materials try to poses an electrical charge in response to applied mechanical stress on it. The inserted piezoelectric material result to charging by changing the mechanical weight applied into current and that is stored in a battery and further used to charge the mobile by using RFID card.

## II. HARDWARE IMPLEMENTATION

The advanced footstep power generator is shown below with the help of block Diagram using RFID for charging. When weight is put on piezoelectric plate's voltage come across the plates. That voltage is used for charging. LCD attached with piezo sensor using microcontroller allows monitoring the voltage and charging that are attached to battery.

RFID helps in identifying the authorized user for charging & it have USB and phone charging connection.

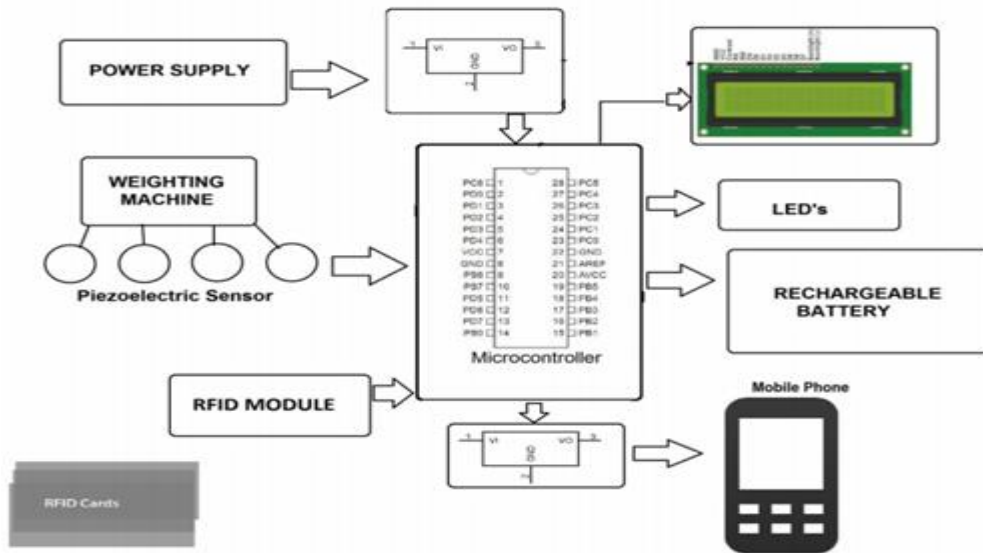

**FIGURE- 1:** Proposed Block diagram

**III. WORKING**

FPG works on the principle of piezoelectric effect. It has ability to generate energy by applying mechanical force to it. Piezoelectric crystals have tendency to behave neutral and atoms are also asymmetrically arranged, but the charge is always balanced. The total positive charge and total negative charge appears on opposite side of crystals and through which they cancel out each other.

By pressurizing or compressing the crystal, the voltage that produce over opposite faces that is known as

piezoelectricity. The same phenomenon is used in this project.

By pressing by step on disc the crystals get compressed and voltage develops & the started charging. After shaft is lifted and a crystal is released. Thus, full vibration is recorded by a disc and a voltage is produced. Voltmeter senses the voltage and displayed it. This voltage is used to charge nearly 12v DC battery. LEDs are fixed under weight machine which is switched on by relay 555 timer IC after voltage is generated. Thus, whenever someone walks through it the system gets charged and voltage is also observed on Voltmeter.

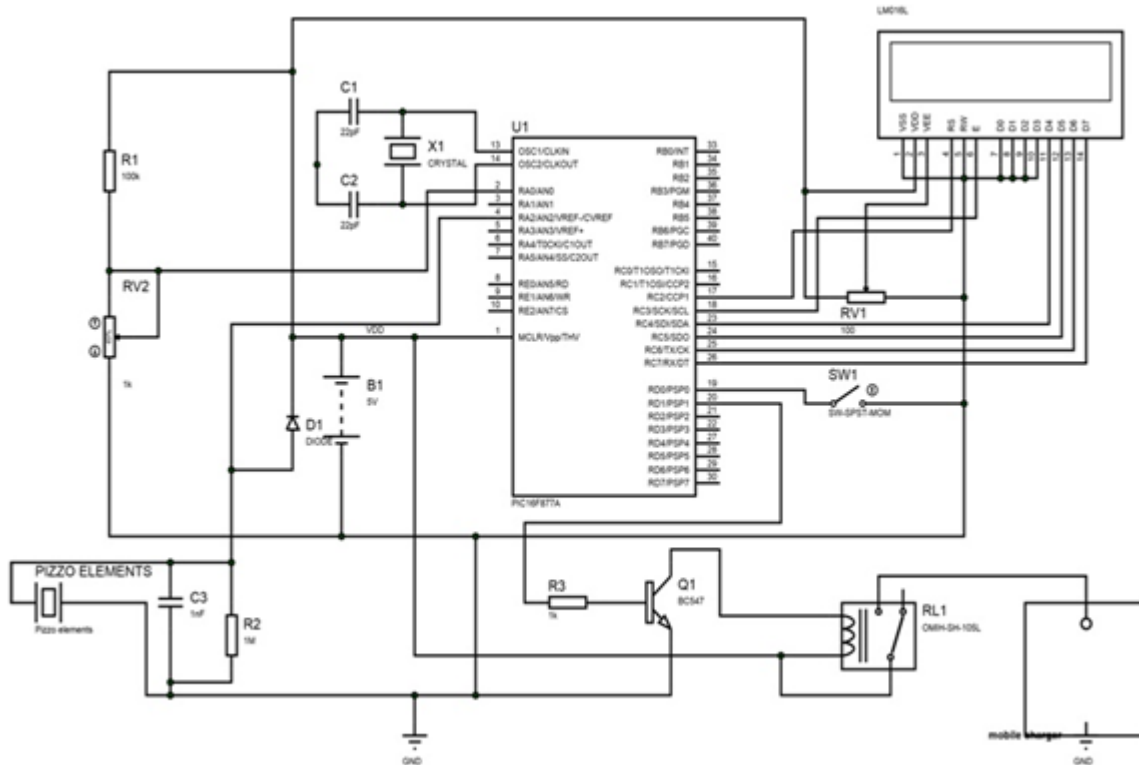

**FIGURE-2:** Circuit Diagram

**IV. COMPONENTS USED**

**(a) USB Cable –**

USB is basically an IS that specifies the standards for cables, connectors and protocols for establishing connections, communication and power supply among computers and its peripherals. It has 2 wires for power of +5v and a ground wire and other 2 twisted wire to carry data.

In this project USB is used so that people can connect their phone via system.



**(b) Inductor -**

A passive component which has a coil of wire around it that helps it to conduct current through it. It also develops a relation between magnetism and electricity to pass current through it.

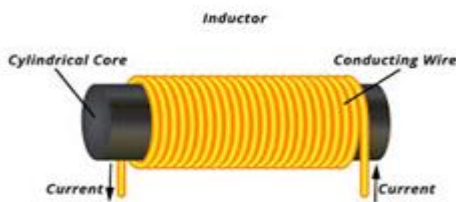

**(c) Resistor -**

A resistor is a 2-terminal passive electrical component that is used in the proposed project for electrical resistance as usual. Its other applications in the proposed circuit are to reduce current flow, signal level adjustment, voltage division etc. It dissipates energy.



**(d) Capacitor-**

A Capacitor is a 2-terminal passive component that has the ability to store electrostatic energy between its 2-plates.



**(e) Transistor-**

A transistor is 3-terminal semiconductor device which can be used as amplifying device in its Forward and reverse active region and as a switching device also in its cutoff and saturation region. In its amplifying stage it is used in the proposed project for charging battery.

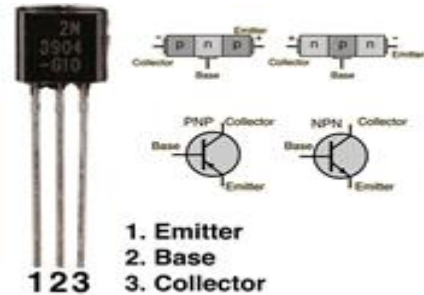

**(f) LCD (16\*2) Display –**

The LCD stands for Liquid Crystal Display. It is a popularly used display module which got its applications in number of devices like mobile phones, calculators, computers etc. It has 2 registers like data register and command register. Its operating voltage is 4.7-5.3V. It utilizes a minimum current of 1mA with no backlight.

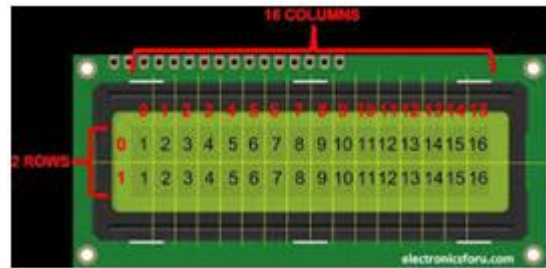

**(g) PCB & Breadboard –**

A breadboard is basically the first step component before creating a printed circuit board. You can change and move circuits on PCB. Also the breadboards are used for designing.

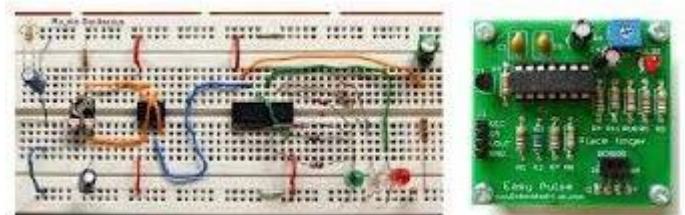

**(h) LED–**

A light-emitting diode (LED) is a semiconductor light source device which has tendency to emit light when current starts flowing through it. Electrons in the semiconductor recombine with electron and holes pair, releasing the energy in the form of photons thus emitting light.

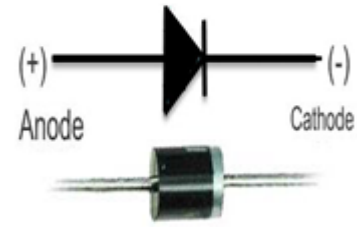

**(l) IC & IC Sockets –**

It consists of many electronic circuits on a small piece of semiconductor normally silicon. It is a component interconnect that uses to connect many components on a single semiconductor. It consists of two parallel rows with connecting pins.

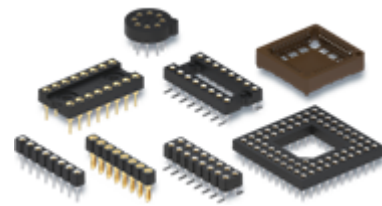

**(m) Crystal Oscillator –**

It operates on the principle of reverse piezoelectric effect that causes it to vibrate to its natural frequency when AC voltage applied across the crystal. These vibrations are further turned into oscillation.

For clock signal it is connected to microcontroller.

Crystal Oscillator Circuit and Working

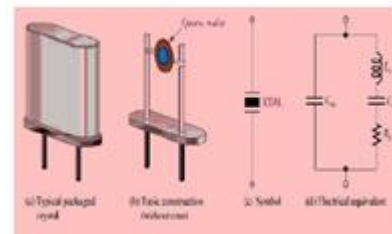

**(n) Atmega microcontroller –**

It is from AVR family of microcontroller. It is of 8 bit with RISC architecture.

- The power stored in battery later use to charge the phones using RFID card.



**(i) Arduino Integrated Development Environment (IDE)**

It is a Software (IDE) – it uses a text editor for writing code, a message box, a toolbar for some functions and a junction of menus. It is then connected by the hardware system to upload programs.

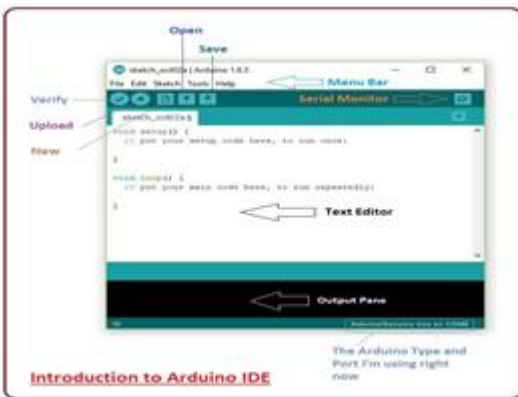

**(j) Transformer -**

It is an electrical device used to change AC from 1 voltage to another. It designs to form "step up" / "step down" voltage's and follows the principle of magnetic induction; voltage is then developed in the other coil that is known as secondary coil.



**(k) Diodes -**

It consists of two-terminal in which current flows in single direction. Its resistance is low in primary direction, and high in the other. In reverse bias it behaves as a conductor.

**(o) Voltage Regulator -**

It is design to keep the constant voltage level. It is used to regulate voltage according to circuit or components used. It uses negative feedback to check for further voltage.

In this project to obtain constant voltage between 5-12 volts.

**(p) RFID sensor & cards -**

It is a digital card in which data is encoded/ captured by radio waves. It is used to identify the amount/data stored by a user to further use

**V. APPLICATIONS**

- It can be used in crowded places like Railway station, Airports and Bus stands
- This can also be used in Schools, Colleges and offices
- In rainy seasons it can operate street lights rather than using solar lights

**VI. ADVANTAGES**

- No fuel is required in this hence it is ecofriendly
- It is authentic and genuine device
- Usage of Non-sustainable power sources are less
- It is self-producing device using our footsteps

**VII. DISADVANTAGES**

- Primary value of installing this device is more
- Proper management must be there for batteries
- Because the system operates with minimum charge, the high impedance cable is needed for electrical interference
- According to variation in crystal temperature, output of device may vary

**VIII. FUTURE SCOPE**

With a view of future prospect in case of densely populated nations. The optimum use of energy wasted is of very much importance.

- 1) Japan is one of the first liner to use electric principle for generating mechanical energy from Flooring tiles i.e. by using these plates on bus stairs. When someone step in the energy is Generated which leads to increase of steps as well as energy also increased.
- 2) Secondly Europe is setting another milestone in the field by using such plates on dance floors, so if anyone step on to these tiles and dance again the energy is released with which even one can charge their mobile and other handy gadgets.

**IX. RESULT**

In **1 square ft.** we have used 8 piezo sensors.

As piezo sensors the power generating varies at different steps, hence we get

**Min volt= 1V per step**

**Max volt = 10.5V per step**

Also taking an **average of 50Kg weight** pressure that from a single person.

Likewise considering the steps of a 50Kg weighted single person, the average calculation comes out to be:

Increase of 1V charge in the battery it takes 800 steps

So, increment of 12V **in battery total steps** needed are  
 $= (8*800) = 6400 \text{ steps}$

And if implementation our project is done in a populated area where footstep as source will be available, we took an **average of 2 steps in 1 second.**

For **6400 steps** time needed  
 $= 6400 / (60*2) = 53 \text{ minutes. (Approx.)}$

**X. CONCLUSION**

To conclude in reasonable way, if such project is undertaken and tried effective manner may prove the best conservative vital solutions for an average citizen of country. As we know India is a Creative developing nation where administrative vitality is a major test for vast population.

By way of initiating this task one can drive both AC and besides DC loads as indicated by power connected on piezoelectric sensor. This technique yields an affective power generation in highly populated nation like ours. In fact 11% of sustainable power source adds to our liveliness.

Last but not the least if this undertaking is sent to that point we can overcome the vitality emergency issue yet besides making a concrete ecological change worldwide.

**REFERENCES**

- [1]. Prabaharan R, Jayramaprakash A, Vijay Anand. "Power Harvesting by Using Human Foot Step"- International Journal of Innovative Research in Science Engineering and Technology, vol.2, issue 7, July 2013
- [2]. Ramesh Raja R, Sherin Mathew. "Power Generation from Staircase (steps)"- International Journal of Innovative Research in Science Engineering and Technology, vol.3, Issue 1, February 2014
- [3]. Power Generation Using Foot Step Method
- [4]. Itika Tandon, Alok Kumar." A Unique Step towards Generation of Electricity via New Methodology"- International Journal of Advanced Research in Computer and Communication Engineering, vol.3, Issue 10, October 2014
- [5]. Kiran Bobby, Aleena Paul K, Anumol. C.V, Josie Ann Thomas, Nimisha K.K." Footstep Power Generation Using Piezoelectric Transducer"- International Journal of Engineering and Innovative Technology, vol.3, Issue 10, April 2014
- [6]. Jose Ananth Vino, AP. "Power Generation Using Footstep"- International Journal of Engineering Trends and Technology, vol.1, Issue 2, May 2011
- [7]. Alla Chandra Sekhar, B Maruti Kishore, T Jogi Raju. "Electromagnetic Foot Step Power Generation"- International Journal of Scientific and Research Publication, vol.4, Issue 6, June 2014
- [8]. Shiraj Afzal, Farrukh Hafeez. "Power Generation Footstep"- International Journal of Advancement in Research and Technology, vol.3, Issue 4, April 2014
- [9]. K. Ramakrishna, Guruswamy Ravana, Venu Madhav Gopaka. " Generation of electrical Power through Footsteps"- International Journal of Multidisciplinary and Current Research
- [10]. Umeda, M., Nakamura, K., and Ueha, S. Energy Storage Characteristics of a Piezo generator Using Impact Vibration. Japan Journal of Applied Physics, Vol. 36, Part 1, No. 5b, May 1997, pp.3146-3151.
- [11]. Design Study of Piezoelectric Energy- Harvesting Devices for Generation of Higher Electrical Power Using a Coupled Piezoelectric-Circuit Finite Element Method IEEE Transactions on Ultra Sonic's, Ferroelectrics, and Frequency Control, vol. 57, no. 2, February 2010.