

Design and Analysis of a Hypersonic Inlet for a Scramjet Engine at Mach 6

¹Sathishkumar S ; ²Loganathan N ; ³Hariharan A ; ⁴Prasath M S

Department of Aeronautical Engineering, Bannari Amman Institute of Technology, Sathyamangalam, India

Abstract:- A two-dimensional hypersonic inlet model that displays self-beginning/self-starting characteristics is designed with various level of choking proportions at a freestream Mach number of $M_\infty = 6$, without the use of variable geometry in order to find an optimal 2D geometry for Mach 6. An introduction of scramjet engine as well as its primary component, the inlet, is given in the beginning. The configuration of scramjet intake geometry consisting of two exterior compression ramps, followed by a subsequent inlet and interior isolator, is chosen. The flow conditions are incoming Mach 6 with free-stream temperature of $T_\infty = 226.65\text{K}$ and Free stream Pressure of $P_\infty = 1171.87\text{ Pa}$ is considered with respect to the operating altitude of 30,000 Meters. Consequently, oblique shock wave will be formed and its interaction with viscous boundary layers will lead to flow separation that is responsible for the loss of mass flow, total pressure and several other effects. Next, 2D CFD simulations are carried out for same inlet geometries that are constructed based on the results of the theoretical analysis using the K-Omega SST turbulence model in Fluent. As expected, due to the presence of throttling plug, the mass flow rate inside the inlet tends to oscillate front and back with increase in TR, which leads to the unstart condition of the designed inlet. Lastly, the conclusion of design process is shown graphically and the steady, unsteady flow conditions are shown using a simplified frequency f parameter.

Keywords:- Hypersonic Inlet, Steady, Transient, Shock Waves, Mach Number.

I. INTRODUCTION

Over thousands of research and development programs had been done to develop a hypersonic flight in the late 1950's and early 1960's. And then it has been found that rocket propelled vehicles were not a practical option for hypersonic flight. So, scientists had developed a engine with the help of ramjet which comprises of major hallow chambers, but the working looks too tedious. This modification to the ramjet engine is called supersonic combustion ramjet, or usually referred as scramjet. The maximum practical potential to reach by a scramjet is up to at least Mach 15. A scramjet engine consists of four major parts: inlet, isolator, combustor and nozzle.

The first component of a scramjet engine is the inlet. It is responsible for guiding the supersonic flow with optimal

pressure, temperature and mass flow rate to the combustor for effective combustion of fuel. Hence, the inlet is considered to be a critical component which affects greatly the overall efficiency of the whole scramjet engine. One major challenge of scramjet inlet design is the ability of the engine to operate over a wide range of Mach number without changing the geometry of the inlet. As the structure of the oblique shocks compressing the flow depends directly on the number of ramps and the angles between each pair of adjacent ramps, the obvious solution for a scramjet engine to operate over a wide Mach number range is to change these parameters. This however leads to a complex inlet structure, with a challenging problem. Therefore, the desired solution is to keep a fixed inlet geometry that doesn't descends the performance of the inlet, thus the engine capable of operating in various Mach number than the Mach velocity designed for this particular inlet. This study aims to design an inlet operating from Mach 5.5 to Mach 6. Without the use of variable geometry.

In this study, various inlet design criteria is considered for the optimal inlet design and can be found and experiments carried out with respect to the operating conditions. Then CFD turbulence modelling in Fluent allow us to supervise and optimise the performance of the inlet and to capture complex flow properties of the flow through the inlet.

II. PARAMETERS TO BE CONSIDERED FOR INLET DESIGN

A hypersonic speed implies that an object is travelling at very high velocity. The "sonic" refers to the speed of sound, so hypersonic implies an object is travelling at many times to the speed of sound. In this paper we construct a hypersonic inlet for scramjet engine and operated at Mach 6. In general hypersonic region are started at Mach 6 and ended with Mach 10. As Scramjet (Supersonic combustion ramjet) is an air breathing engine, uses the atmospheric air for its combustion process. Then the engine is integrated into an atmospheric vehicle. In the inlet the air slow down and its pressure and temperature increase rapidly, as the inlet consists of ramp, shock waves are generated with respect to the number of ramps in the inlet area. As the number of ramps decides the overall efficiency of the inlet, consecutively determines the drag produced in inlet. Here, we construct two ramps so two shock waves are generated and acts as an external compression inlet. For ideal flow this inlet compresses the air so that the flow leaving the inlet is uniform and all travelling in same direction. The inlet is

responsible for supplying a supersonic flow with suitable pressure, temperature and mass flow rate to combustor. Hence inlet is critical component its affect overall efficiency of engine. Our objective is to design and perform CFD analysis of hypersonic inlet at Mach number 6 and determining the start and unstart condition, with the help of an obstacle component called plug, which is responsible for the back pressure created inside the isolator, which tends to create a fluctuation in mass flow, which is then compared to the results of inlet designed for Mach 5.5 without any variable geometry.

OBLIQUE SHOCKWAVE RELATIONS

The main goal of the oblique shockwave relations is to find the shock angle β , the flow properties downstream of the shockwave based on known upstream condition and the turning angle δ , assuming that the flow through the inlet is one – dimensional, and ideal. Ideal gas is the perfect gas with constant gas index: $\gamma = 1.4$ and heat transfer between the flow and the inlet wall is neglected.

First, β can be found using Eqn. (1):

$$\tan \delta = 2 \cot \beta \frac{M_1^2 \sin^2 \beta - 1}{M_1^2 (\gamma + \cot^2 2\beta) + 2} \tag{1}$$

Two values of β can be found from Eqn. (1), the corresponding low and higher which relays to a weak and a strong oblique shock respectively.

With known free stream condition, flow properties after the oblique shock can be calculated using the following equations:

$$M_{n1} = M_1 \sin \beta \tag{2}$$

$$M_{n2} = \sqrt{\frac{1 + [(\gamma - 1) / 2] M_{n1}^2}{\gamma M_{n1}^2 - (\gamma - 1) / 2}} \tag{3}$$

$$M_2 = \frac{M_{n2}}{\sin(\beta - \delta)} \tag{4}$$

$$\frac{P_2}{P_1} = 1 + \frac{2\gamma}{\gamma + 1} (M_{n1}^2 - 1) \tag{5}$$

$$\frac{\rho_2}{\rho_1} = \frac{(\gamma + 1) M_{n1}^2}{2 + (\gamma - 1) M_{n1}^2} \tag{6}$$

$$\frac{T_2}{T_1} = \frac{P_2}{P_1} \cdot \frac{\rho_1}{\rho_2} \tag{7}$$

FREE STREAM CONDITIONS

Before the implementation of scramjet inlet design, it is necessary to decide the operating condition for it. As it is

a hypersonic vehicle, there must be a specific constrain for its operation. In general turbojet engines can able operate only within the stratosphere extent, which is about 10 to 50 Km. But in case of a hypersonic vehicle, they can be operated beyond stratosphere and within mesosphere which is about 50 to 80 Km. To reduce the complications such as ionization and atomization of Nitrogen, Hydrogen, Oxygen and other gases present in the higher altitude, an nominal altitude and its corresponding parameters as taken as the operating condition and it is tabulated below.

Table 1: Free stream operating conditions for inlet.

PARAMETERS	VALUES
Altitude	30,000 Meters
Mach number	6
Freestream Pressure, P_∞	1.17187E+3 Pa
Freestream Temperature, T_∞	226.65 K
Total Pressure, P_0	18.5E+5 Pa
Total Temperature, T_0	1858.5 K
Gamma	1.4
Gas Constant	287 J/Kg K

INLET DESIGN

For the above mentioned free stream conditions, the inlet design is done with the help of CATIA V5 CAD software. And their respective design values are tabulated below:

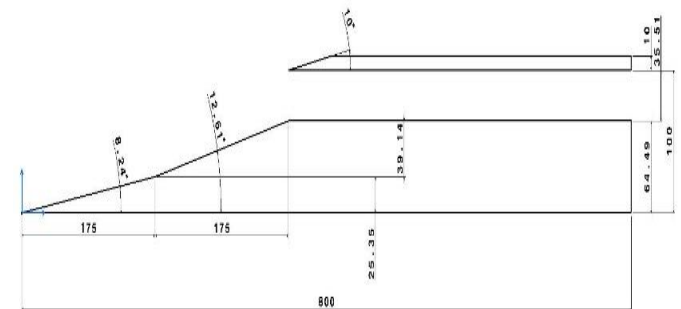

Fig 1: Scramjet Inlet Design

Table 2: Inlet Design Geometrical parameters.

PARAMETERS	VALUES
Inlet Length	350 mm
Capture Height, h_c	100 mm
Total Length, L	800 mm
Height of Ramp 1, h_1	25.35 mm
Height of Ramp 2, h_2	39.139 mm
Length of Ramp 1&2	175+175=350 mm
Isolator Height, h_3	35.511 mm
Ramp Angle, δ_1	8.242 degree
Ramp Angle, δ_2	4.365 degree
Shock Angle, β_1	15.9 degree
Shock Angle, β_2	14.859 degree

NUMERICAL METHOD

A schematic diagram of the domain of the external compression hypersonic intake is shown in Figure 3. The intake is designed for a Mach number 6.0 in such a way that the oblique shocks emerging from the two steps of forebody

semi-wedge interact with cowl lips. The external compression is realized through two oblique shocks emerging from two successive steps of the semi-wedge with a wedge angle of 8.2 and 4.3 respectively. The semi wedge angle has been chosen in such a way that the contraction area ratio of the wedge obeys the area ratio proposed by the Kantowitz limit After achieving compression by turning an angle of 12.5° in the two steps, an extension of flow through the constant area passage has been established by turning 12.5° in the opposite direction as an expansion corner. Using inviscid shock theory, the location of reflected shocks in the forebody from the cowl lip has been identified.

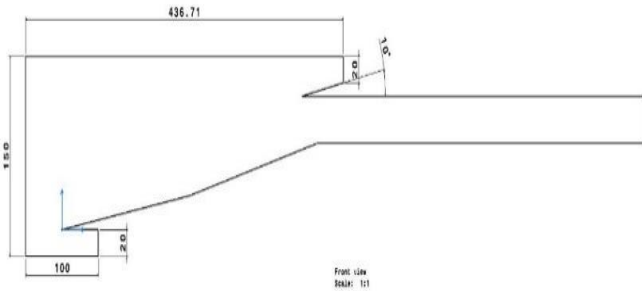

Fig 2: Scramjet Inlet Domain

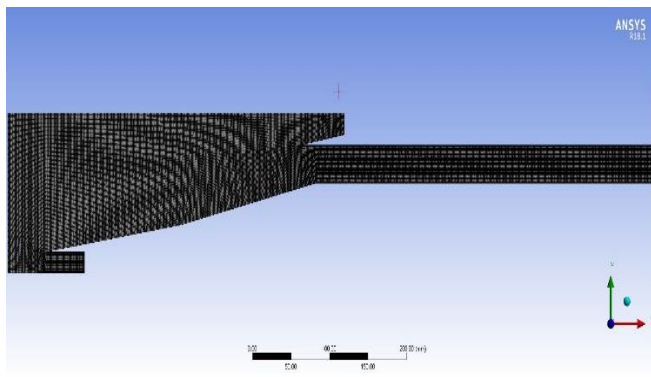

Fig 3: Meshed Domain

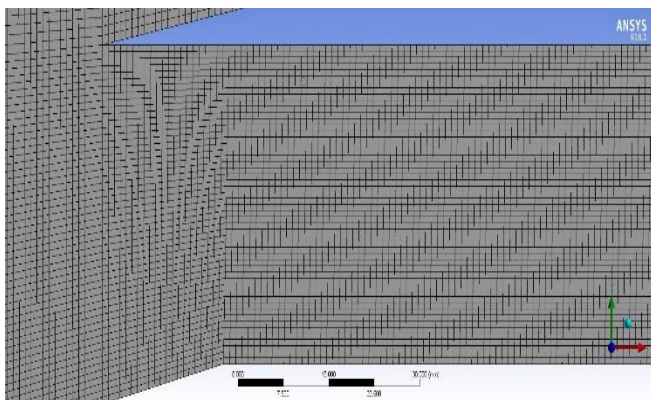

Fig 4: Fine Structured mesh with quality of 0.9

The domain is modified from its actual design so that it can able to adapt the numerical process. The numerical simulation is carried out in the flow domain guiding towards the hypersonic inlet by solving steady, compressible Navier-Stokes (RANS) equations with k- ω SST turbulence model using CFD. An explicit coupled solver with a second order

upwind discretization method for the convective terms was taken in account. The free stream turbulent intensity has been specified as 5 % in default at the inlet. The residuals of continuity, x-velocity, y-velocity, energy, and turbulent kinetic energy were monitored for solution convergence.

GOVERNING EQUATIONS

Continuity equation:

$$\frac{\partial \rho}{\partial t} + \frac{\partial(\rho u_k)}{\partial x_k} = 0 \quad k = 1, 2, 3$$

Momentum equation

$$\frac{\partial(\rho u_i)}{\partial t} + \frac{\partial(\rho u_i u_k)}{\partial x_k} + \frac{\partial P}{\partial x_i} = \frac{\partial \tau_{ik}}{\partial x_i} \quad i, k = 1, 2, 3$$

Energy equation:

$$\frac{\partial(\rho E)}{\partial t} + \frac{\partial(\rho u_k H)}{\partial x_k} = - \frac{\partial(u_j \tau_{jk})}{\partial x_k} + \frac{\partial q_k}{\partial x_k} \quad j, k = 1, 2, 3$$

Were, the terms ρ, u_i, p, E and H represents the density, velocity components, pressure, total energy and enthalpy respectively.

VALIDATION OF NUMERICAL METHOD

Even though this numerical method that has been validated in the existing literature for various aerodynamic flow problems ranging from incompressible to supersonic Mach No. The numerical technique equipped here is validated with the experimental results reported in the *Li 2013*, were the unsteady behavior of hyper sonic inlet due to throttling is observed in shock tunnel. Were the relative pressure in the isolator wall was considered for the conclusion. The *Li 2013* model comprises of two constructive ramps which is similar to the current study. And also deals with the identical throttling ratio concepts in the current study. For validation purpose, one of the results produced in the *Li 2013 (Time-averaged pressure distribution within the isolator)* is taken in account and the same experiment is repeated without any throttling, with the help of conditions and design parameters available in it. Then the acquired results are plotted as per the data in *Li 2013*.

Table 3: Numerical method validation data using relative pressure in *Li 2013*.

X distance (mm)	P, (Li-2013)	P/P0
13	20	24.8
36.6	5.5	7.8
60	24	24.3
95.5	12.8	14
119	21	23
143	17	20
166	15.5	19
200	16	20

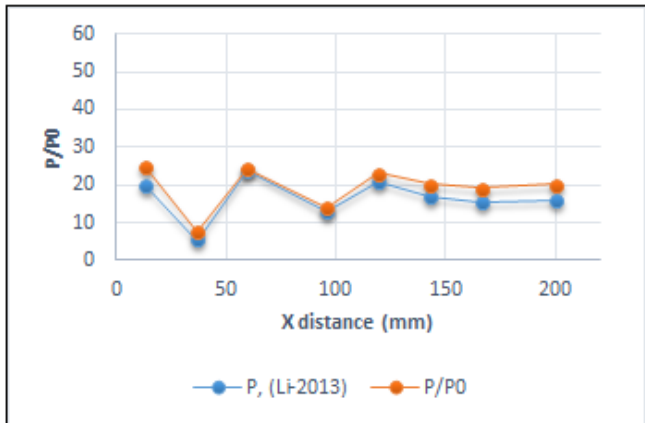

Fig 5

III. RESULTS AND DISCUSSION

A. STEADY STATE RESULTS

As the initial stage of simulation and to confirm the accuracy of the inlet design, the steady state solver is used and contours are visualized on pressure, temperature, static pressure and velocity. By that it is assured that the inlet design with two consecutive ramps at an angle of 8.2 degree and 4.3 degree have done its job perfectly by letting the external compression happens due to the formation of two constructive shock waves and reaches the cowl lip and leads to the formation of successive shock train inside the isolator region.

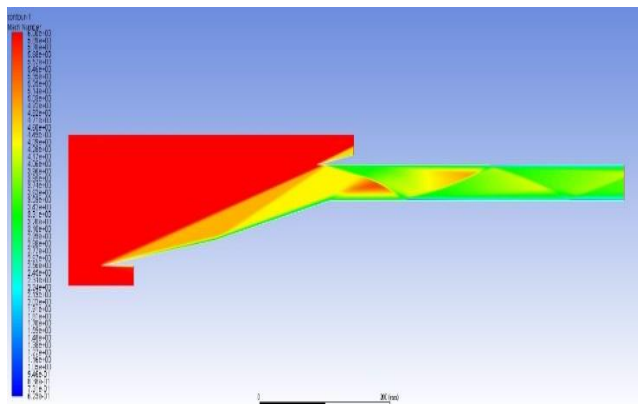

Fig 6: Velocity Contour for Mach 6.

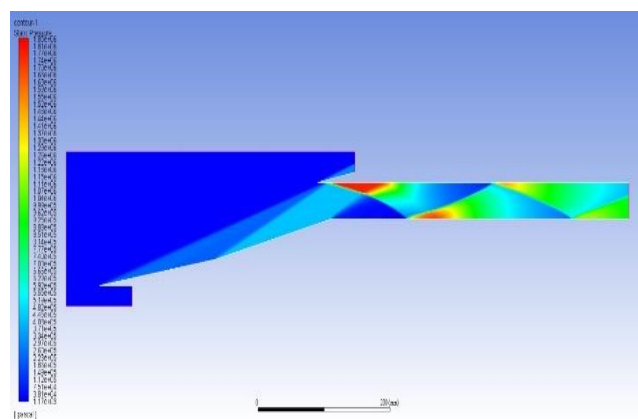

Fig 7: Static Pressure for Mach 6.

Table 4: Analytical Vs Numerical Data (Steady State)

Parameters	Analytical	Numerical
Mi	6	6
M1	4.88	4.81
M2	4.45	4.41
Ti	226.65 K	226.65 K
T1	322.33 K	328.2 K
T2	374.13 K	378.5 K

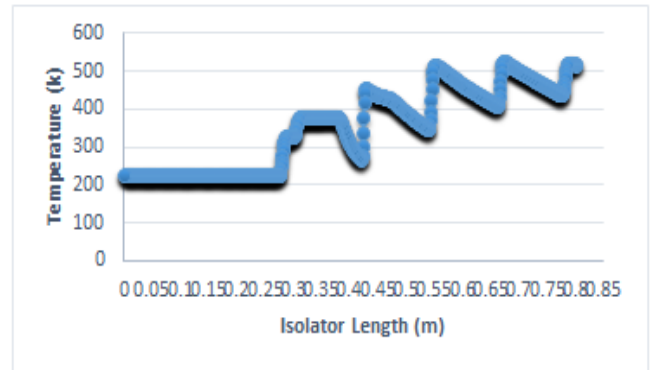

Fig 8: Temperature across the Isolator

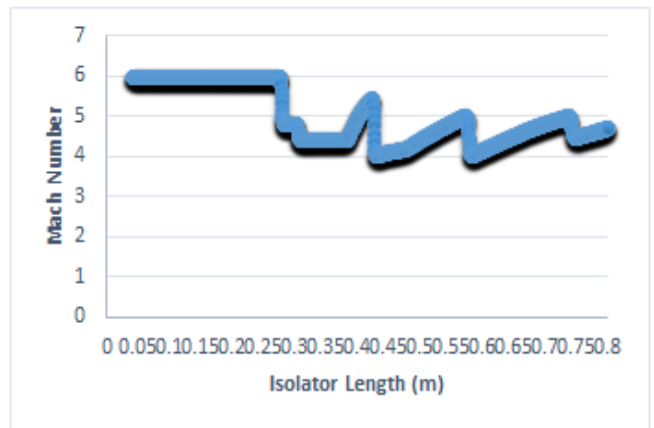

Fig 9: Mach across the Isolator

B. THROTELLING RATIO

Before each test, a plug with a wedge angle of 20 degrees and a length of 100 mm can be placed near the isolator exit to simulate the high backpressure induced by combustion. Were, the main purpose of the plug is to substitute/replace the effects of back pressure created inside the inlet during the combustion process. The inlet operating conditions can set to be constant by changing the plug height, which is related to the throttling ratio (TR) as follows:

$$\zeta = 1 - (h^* / h) \quad (8)$$

The initial predictions of possible throttling ratios are made using the plots of isentropic area ratio variation and Kantrowitz limit for different inlet Mach numbers (Mi). The lowest throttling ratio ($\zeta = 0$) indicates the started flow with the desired mass flow rate passing into it. On the other hand, the highest comes from the practical limit of maximum area contraction ratio for which the inlet could still be started ($\zeta = 0.7$). Larger values render the inlet into the unstart regime of

operation. Hence, for the present analysis, the throttling ratio is varied only between $0 \leq \zeta \leq 0.7$ in steps of 0.0035.

Kantrowitz limit - The **Kantrowitz limit** refers to a theoretical concept describing choked flow at supersonic or near-supersonic velocities. When an initially subsonic fluid flow experiences a reduction in cross-section area, the flow speeds up in order to maintain the same mass-flow rate, per the continuity equation.

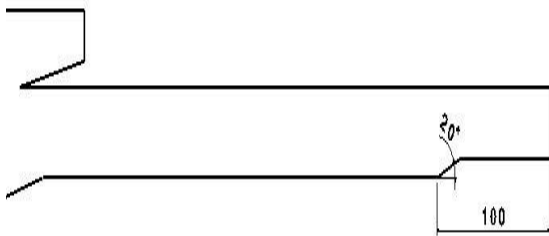

Fig 10: Throttling plug on the Exit.

conditions. Consider a two-dimensional rectangular duct that represents the isolator portion of the hypersonic inlet (Figure 11). The isolator duct as two stations: a. inlet (1) and b. outlet (2). The duct has a constant area (A_1) except at the outlet, where the area is $A_2 < A_1$. The unsteady frequency (f) contributes to the mass flow in and out across the isolator region. It is similar to the identification of mass in (m_i) and mass out (m_o). The mass flow rate could be scaled using a parameter called β using the net mass occupied inside the isolator ($\rho_1 A_1 L$) duct based on the inlet conditions, and the allowed mass flow rate across the outlet ($\rho_2 A_2 u_2$) as,

$$\beta = \frac{\rho_1 A_1 L f}{\rho_2 A_2 u_2} = \left(\frac{\rho_1}{\rho_2}\right) \left(\frac{A_1}{A_2}\right) \left(\frac{f L}{u_2}\right) \tag{9}$$

Where ρ , u , A , and L are the density, velocity, cross-sectional area and length of the isolator at respective stations. Equation (9) is modified using Equation (8) and rewriting u in terms of M and a as,

$$\beta = \left(\frac{\rho_1}{\rho_2}\right) (1 - \zeta)^{-1} \left(\frac{f L}{M_2 a_2}\right) \tag{10}$$

Let's assume the term Γ in the isentropic relation, which is a function of M alone (as we're dealing air, the ideal gas with $\gamma = 1.4$) as,

$$\Gamma(M) = [1 + (\gamma - 1) / 2] * M^2 \tag{11}$$

The term a_2 , ρ_1 , and ρ_2 in Equation (10) can be further rewritten using the one-dimensional isentropic flow relations as,

$$a_2 = a_0 / \Gamma(M_2) \tag{12}$$

$$\rho_2 = \rho_0 * \Gamma(M_2)^{-1 / \gamma - 1} \tag{13}$$

$$\rho_1 = \rho_0 * \Gamma(M_1)^{-1 / \gamma - 1} \tag{14}$$

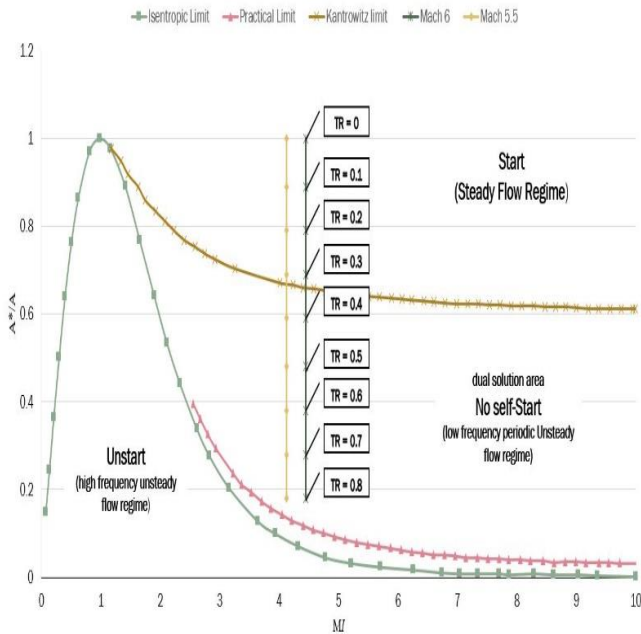

Fig 11: A plot of ratio of generic throat area (A^*) and the capture area (A) to different inlet Mach numbers (M_i) to map out the regions of self-start, no self-start, and unstart zones with respect to the hypersonic inlet. The inlet Mach number to the considered hypersonic inlet in the present study is $M_i = 4.45$ for Mach 6 and $M_i = 4.12$ for Mach 5.5 obtained from the two-dimensional $\theta - \beta - M$ relationships of compressible aerodynamics at the inlet cowl/ramp plane.

C.THEORETICAL FORMULAE

Unsteady and Steady two dimensional numerical studies are simple in comparison to the three-dimensional study as it saves computational space and time. In fact, running simulations for every throttling condition adds further complexity, which could be avoided if a relation is available to estimate the frequency. A relation is formulated to calculate the frequency based on the available design

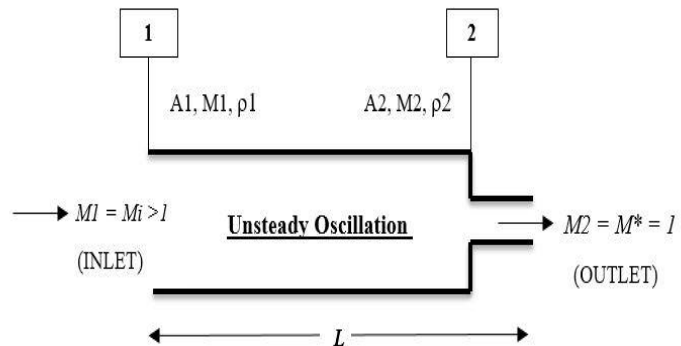

Fig 12: Two dimensional rectangular duct, represents the unsteady oscillation inside the isolator due to throttling ζ . As the above rectangular duct shows the reduction in area A^* over the outlet region, hence $A_1 > A^*$, the high velocity air which is greater than Mach one, will be choked/blocked

when it tries to cross from region (1-INLET) the region (2-OUTLET). In which a back pressure in terms of mass flow oscillation occurs with respect to frequency f . Substituting the values from Equation (12-14), and $M2 \rightarrow M^* = 1$ in to Equation (10).

$$\beta = \Gamma(1) [\Gamma(M1) / \Gamma(1)]^{(-1/\gamma-1)} * [L/f] a_0 (1-\zeta) \\ = \Pi(M1)L/f a_0 (1-\zeta) \tag{15}$$

Equation (15) can be re-written in terms of frequency f ,
 $f = [\beta * a_0 (1-\zeta)] / \Pi(M1)L \tag{16}$

Were, $\beta = a\alpha^b + c$
 $\alpha = M_i / M_\infty (1-\zeta)$
 $a = \text{sqrt}(\gamma RT)$
 $\Pi(M) = \Gamma(1) * [\Gamma(M1) / \Gamma(1)]^{(-1/\gamma-1)}$
 $\Gamma(M1) = [1 + (\gamma-1) / 2] * M_i^2$
 $\Gamma(1) = 1 + (\gamma-1) / 2$

RESULTS OBTAINED

Finally, the unsteady flow analysis is performed following the successful confirmation of inlet design by means of steady state analysis, and their results are shown in Figure.5, 6, 7 and 8. Linearly the transient analysis is done for the same operating condition that's excited in steady state. With respect to transient analysis, the only difference is variation in time. (i.e, if Temperature, velocity, mass flow rate does not varies with time, it is said to be steady state, on the other hand, if temperature, velocity and mass flow rate varies with respect to time, then it is said to be transient/unsteady state). In this study, the time set-up for a single cycle is about 3500 time steps, were the estimated total time is 0.0035 Seconds. By calculating the frequency of the mass flow oscillation inside the isolator, we can easily predict the start and unstart/chocking condition of the inlet design with respect to the throttling ratio $0 \leq \zeta \leq 0.7$. Then the validation is done by comparing the obtained frequency from numerical process and the frequency values obtained from analytical calculation using equation (16) or by using the formulated C program in Figure 12.

$$\text{Frequency} = 1 / T \tag{17}$$

As the formulation for calculating the numerical frequency is to take the time taken by the certain inlet model with its respective throttling ratio ζ . And then the general formulation for frequency (17) calculation is used to get the numerical frequency f data.

Table 5: Analytical Vs Numerical Frequency f Data for Mach 5.5 (Transient/Unsteady State)

THROTTLING RATIO	ANALYTICAL FREQUENCY	NEUMERICAL FREQUENCY
0	0	0
0.1	0	0
0.2	0	0
0.3	0	0
0.4	199	200
0.5	237	250
0.6	278	294
0.7	325	333

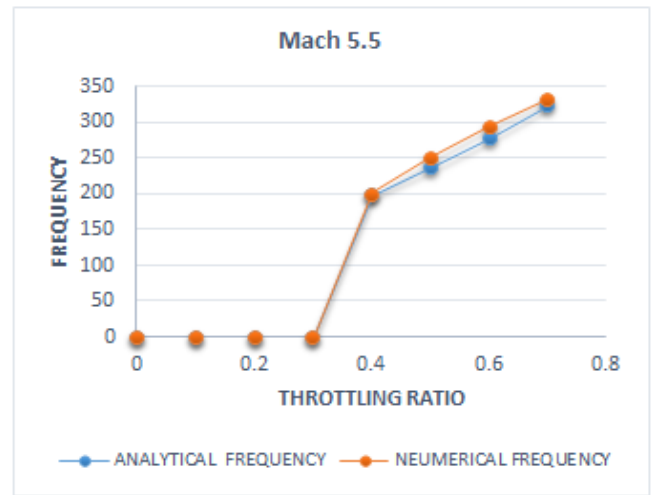

Fig 13: Frequency f plot with respect to Throttling ratio ζ for free stream Mach $M_\infty = 5.5$

Table 6: Analytical Vs Numerical Frequency f Data for Mach 6 (Transient/Unsteady State)

THROTTLING RATIO	ANALYTICAL FREQUENCY	NEUMERICAL FREQUENCY
0	0	0
0.1	0	0
0.2	0	0
0.3	0	0
0.4	0	0
0.5	326	285
0.6	382	307
0.7	446	322

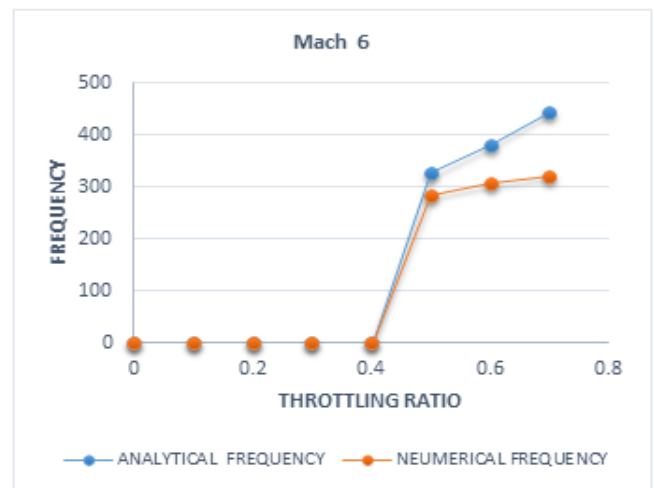

Fig 14: Frequency f plot with respect to Throttling ratio ζ for free stream Mach $M_\infty = 6.0$

IV. CONCLUSION

A Simple two-dimensional rectangular hypersonic external compression inlet is considered to understand the unsteady fluid flow observed in the inlet-isolator flow due to throttling by numerical method in comparison with analytical means. The throttling is simulated by placing a wedge-plug of varying heights at the isolator section's exit, thereby implementing different throttling ratios between $0 \leq$

$\zeta \leq 0.7$ in steps of 0.0035 as the inlet is exposed to a freestream Mach number of $M_\infty = 6.0$ and 5.5. The flow field is achieved computationally by solving the unsteady Reynolds Navier-Stokes (URANS) equations with a $k-\omega$ -SST turbulence model.

- Throttling has negligible effects on, the exit mass flow rate between $0 \leq \zeta \leq 0.4$ (i.e., Start-Steady Flow Regime) in inlet of Mach 6 and $0 \leq \zeta \leq 0.3$ in the inlet of Mach 5.5.
- The contraction of area achieved by throttling pushes the inlet to enter into the unsteady operation region, as ζ increases between $0.5 \leq \zeta \leq 0.7$ (i.e., dual solution area, No self-Start-low frequency periodic Unsteady flow regime).

ACKNOWLEDGEMENT

Thanks to Asst. prof Mr Prasath M S for his devoted guidance and the work he has done –working in conjunction with Dr. Rajasekar K. The clarity of her comments in the designing and analysis of the Rotor Blade allowed me to complete the article with expected results.

REFERENCES

- [1]. L. H. Quan, N. P. Hung, L. D. Quang and V. N. Long, “Analysis and Design of a Scramjet Engine Inlet Operating from Mach 5 to Mach 10.”
- [2]. Kristen Nicole Roberts, “Analysis and Design of a Hypersonic Scramjet Engine with a Starting Mach Number of 4.”
- [3]. Y. Yao, D. Rincon and Y. Zheng, “Shock Induced Separating Flows in Scramjet Intakes.”
- [4]. J. Haberle and A. Gulhan, “Investigation of Two-Dimensional Scramjet Inlet Flow field at Mach 7.”
- [5]. N. Om Prakash Raj and K. Venkatasubbaiah, “A New Approach for the Design of Hypersonic Scramjet Inlet.”
- [6]. K. Raja Sekar, S. K. Karthick, S. Jegadheeswaran and R. Kannan, “On the unsteady throttling dynamics and scaling analysis in a typical hypersonic inlet-isolator flow.”
- [7]. Zhufei Li, Wenzhi Gao, Hongliang Jiang, and Jiming Yang, “Unsteady Behaviors of a Hypersonic Inlet Caused by Throttling in Shock Tunnel.”
- [8]. K. Raja sekar, S. Jegadheeswaran, R. Kannan and P. Manigandan, “Perforated Wall in Controlling the Separation Bubble Due to Shock Wave –Boundary Layer Interaction.